

MICHIGAN STATE
UNIVERSITY



MICHIGAN STATE UNIVERSITY *Spring 2015*
Design Day
COLLEGE OF ENGINEERING

 **MICHIGAN
STATE
UNIVERSITY®**
FEDERAL CREDIT UNION

Executive Partner Sponsor



Building Dreams. Building Community.

Welcome to MSU College of Engineering Design Day!

On behalf of Michigan State University Federal Credit Union (MSUFCU) in partnership with the College of Engineering, and Michigan State University, we would like to welcome you to the beautiful campus of MSU and this extraordinary program.

MSUFCU is proud to partner with MSU on many programs, but the ones that are most special, are those that highlight the talents of MSU's outstanding students. Today, you will experience the work of MSU students demonstrating their abilities to be creative, innovative, and problem solve—traits that we all seek in our next generation of employees.

Design Day showcases the students' unique skills exhibited in their intellect, ingenuity, teamwork, and core engineering knowledge learned during their academic tenure in the College of Engineering. As we observed the students' projects this semester, they provided insight into their inspiring solutions to the real-world challenges presented. As a result, we have great confidence in their futures as engineers and leaders in our global workforce.

We wish everyone in attendance our congratulations on your successes and accomplishments. And, a special thank you to the parents, faculty, and staff that have supported the students as they achieve their dreams.

Sincerely,

April M. Clobes
President/CEO, Michigan State University Federal Credit Union



www.msufcu.org/careers

MSUFCU has been named:

#1 Top Workplace in Michigan by *Detroit Free Press*
#1 Employer in Large-Employer Category

2014 Federal Credit Union of the Year
National Association of Federal Credit Unions

#1 Credit Union to Work For
Credit Union Journal

Table of Contents: May 1, 2015

Welcome from the Dean: Dr. Leo Kempel.....	4
Design Day Events Schedule and Engineering Building Floor Plan: Friday, May 1, 2015.....	5-7
The Dart Foundation Day, Friday, May 1, 2015: Middle School & High School Events Schedule.....	9-11
EGR 100 Introduction to Engineering Design: Course Project.....	12
Applied Engineering Sciences: Capstone Course Sponsors.....	14
AES Applied Engineering Sciences Capstone Projects: Presentation Schedule – Room 1145.....	15
Ford Motor Company: Planning Part Complexity Management in Automotive Manufacturing.....	16
MSU Office of Sustainability: Spartan Treasure Hunt – Finding Energy Efficiency through Occupant Engagement.....	17
Continental Automotive Systems ADS Business Unit: Benchmarking and Market Assessment for Rear View and SurroundView Camera Systems.....	18
Asahi Kasei Plastics: Bulk Truck Capacity Utilization Analysis.....	19
MSU Office of Sustainability: Customer Service Process for Recycling and Surplus Department.....	20
Consumers Energy Company: Optimizing Logistics Transportation Routing and Scheduling.....	21
The Boeing Company: Cost Model for Utilizing Recycled Carbon Fiber in a Paper-making Process.....	22
BASF Corporation: Master Logistics Plan - Wyandotte, Michigan.....	23
MSU Office of Sustainability: Spartan Treasure Hunt – Finding Energy Efficiency through Occupant Engagement.....	24
MSU Office of Sustainability: Customer Service Continuous Improvement for Recycling and Surplus Department.....	25
GE Aviation: Distribution Model for Raw Materials in the Aerospace Electronics Manufacturing Industry.....	26
MSU Office of Sustainability: Optimization of Water Usage on Campus through Data Collection and Analysis.....	27
MSU Office of Sustainability: Spartan Treasure Hunt – Finding Energy Efficiency through Occupant Engagement.....	28
BE 485/487: Biosystems & Agricultural Engineering.....	31-34
CE 495 Senior Design in Civil & Environmental Engineering: Projects and Presentation Schedule – Rooms 1538, 3400 and 3540.....	35-38
ChE 434: Process Design & Optimization II.....	39-40
MSE 466: Senior Capstone Design in Materials Science and Engineering.....	41-44
Computer Science and Engineering: Capstone Course Sponsors.....	46
CSE 498 Computer Science & Engineering Projects: Presentation Schedule – Engineering Building, Room 3405.....	47
Amazon: SIFT: Seller-Forums Information Filtering Tool.....	48
Auto-Owners Insurance: Claims First Notice of Loss Application.....	49
The Boeing Company: Business Developer’s Electronic Sales Bag.....	50
Ford Motor Company: Electric Vehicle Charging Station App.....	51
General Motors: Employee Companion Mobile Application.....	52
Meijer: Product Availability Check using Glassware.....	53
MSU Federal Credit Union: Financial 4.0 Interactive Budgeting Tool.....	54
Quicken Loans: Parking Allocation and Expense Reconciliation.....	55
Spectrum Health System: Mobile Appointment Check-In and Payment.....	56
TechSmith: Enterprise Learning Activity Capture.....	57
Urban Science: Global Dealer Census and Market Share Viewer.....	58
Whirlpool Corporation: Launder: Laundry Room Tablet Payment System.....	59
Design Day Awards: Computer Science and Engineering Awards.....	60-61
ECE 101 Introduction to Electrical and Computer Engineering: Mechanisms that Fascinate, Captivate, Stimulate and Entice.....	65
ECE 410 VLSI Design: A Programmable (adaptive) Filter in CMOS ICs.....	66
ECE 480 Electrical and Computer Engineering Projects: Presentation Schedule – Rooms 2205 and 2250.....	67
MSU College of Engineering: Surgical Tool Utilized in Unsanitary Conditions.....	68
Dr. Daniel Morris, 3D Vision Lab: Automated 3D Model Building.....	69
Asante Solutions, Inc. & MSU RCPD: Accessible Insulin Pump.....	70
MSU RCPD & College of Engineering: Smart Walker Design.....	71
Instrumented Sensor Technology: Lightning Strike Detector, Counter and Time Log.....	72

(continued on next page)

Program Page/Course Number Index Listing: May 1, 2015

<i>ECE 480 Electrical and Computer Engineering Projects: Presentation Schedule – Rooms 2205 and 2250 (continued from previous page)</i>	
ArcelorMittal: Crane Collision Avoidance	73
ArcelorMittal: Smart Gate	74
MSU Electrical and Computer Engineering: High Resolution Ultrasound for Telemedicine	75
Great Lakes Controls and Engineering: Screw Machine Tool Condition Monitoring.....	76
MSU Technologies: Multi-Material 3D Printer	77
MSU Solar Car Team: CAN Lighting System.....	78
Whirlpool Corporation: Dispenser Cup Design.....	79
MSU Electro-Optics Laboratory: Tunable LED Light Source.....	80
Consumers Energy: Drone Monitoring of Power Lines.....	81
<i>Design Day Awards Fall 2014: Electrical and Computer Engineering Awards</i>	82
<i>ME 371: Mechanical Design I: Thrills for Pre-collegiates: Mechanisms that Fascinate, Captivate, Stimulate and Entice</i>	85
<i>ME 412: Heat Transfer Laboratory: Thermoelectric Generator</i>	86
<i>ME 471: Mechanical Design II: Pick & Place</i>	87
<i>ME 478: Product Development: Stair Climbing Vehicle</i>	88
<i>ME 491: International Humanitarian Engineering</i>	89
Appropriate Technology Collaborative: Human Powered Plastic Recycler	90
Appropriate Technology Collaborative: Panybar Nutrition Center–Solar Powered Fruit Dehydrator	91
<i>ME 497/MKT 420: Biomechanical Design and New-Product Development</i>	92
<i>ME 481 Mechanical Engineering Design Projects: Presentation Schedule – Room 1202</i>	93
Ingersoll Rand: Air Conditioner Packaging Cost Reduction	94
Ingersoll Rand: Improved Design of Roof Panel Assemblies.....	95
Ingersoll Rand: Cost-Effective Impeller-Mount Design.....	96
U.S. Steel: Improved Thermal Efficiency in Bottle Cars.....	97
U.S. Steel: Cover for a Hot Metal Transfer Car	98
Robert Bosch: System to Measure Axial Play in a Throttle Shaft.....	99
DTE Energy: System to Analyze Precipitator Performance.....	100
<i>ME 481 Mechanical Engineering Design Projects: Presentation Schedule – Room 1208</i>	101
Eaton Aerospace: Fixture for Measuring Skewed Roller Bearing.....	102
EMD Technologies: Smart Braking System for Strollers.....	103
Fiat Chrysler Automobiles: Design of a Compliant Fascia Support.....	104
ArcelorMittal: Design of a Secure Facility Entry Gate.....	105
Robert Bosch: Test Bench for Natural Gas Injector.....	106
Ford: Pressure-Reactive Piston Engine.....	107
Gilbarco Veeder-Root: Redesign of a Display Subassembly.....	108

Program Page/Course Number Index Listing: May 1, 2015

<i>ME 481 Mechanical Engineering Design Projects: Presentation Schedule – Room 1220</i>	109
<i>Consumers Energy: Automated Measurement of Liquid Levels</i>	110
<i>IAC International: Redesign of a Paint-Line Rack</i>	111
<i>Kautex Textron: Optimization of Fuel-Tank Baffles</i>	112
<i>Meritor: Design of a Transfer Case Internal-Oil Cooler</i>	113
<i>Melvin Millet Learning Center: Switch-Activated Basketball Shooter</i>	114
<i>Mid-Michigan Children's Museum: Design of an Energy Demonstration Table</i>	115
<i>Whirlpool Corporation: Dual Pumping System for Washing Machines</i>	116
<i>Design Day Awards: Mechanical Engineering Awards</i>	117-118

Mark Your Calendars!! It's time to save the date for Fall 2015 Design Day!

**Join us December 11, 2015,
for another energetic
celebration showcasing
talented engineering
students**

Check our website often for
updates during the semester:
<http://designday.egr.msu.edu/day>

GO GREEN!!



Welcome from the Dean



As Dean of the College of Engineering, on behalf of the entire faculty, I welcome you to Design Day!

We wish you an enjoyable event as you experience our students and their amazing talents through presentations, competitions, demonstrations and posters. This term, all ten academic departments are participating in Design Day.

We are pleased to acknowledge the MSU Federal Credit Union as our Design Day Executive Partner Sponsor and Urban Science as our Design Day Directing Partner Sponsor. Our Design Day Supporting Partner Sponsors include Auto-Owners Insurance, Blackstone Technologies, Bosch, Dow, General Motors, the MSU Innovation Center, Quicken Loans and Whirlpool. We thank all of our sponsors for their generosity and their ongoing commitment to Design Day.

As you explore the exhibits throughout the Engineering Building, you are encouraged to take time to learn about the projects by talking with our students. They are an incredible group of people who love to share their enthusiasm for engineering.

Starting in their first semester, our freshmen learn about the importance of engineering and the positive impact that engineers make on society and the world around them in our Cornerstone and Residential Experience for Spartan Engineers program. Be sure to stop by and see how they innovate, communicate and perform at the highest levels in an increasingly global and demanding world.

Another exciting part of Design Day is the Dart Foundation Day of Engineering Innovation and Creativity for 7th-12th Grade Students, which involves some 200 local junior high and high school students. On Design Day, these future engineers explore design principles with hands-on projects requiring the application of their creativity and ingenuity.

The headliners of Design Day are our graduating seniors as they present their design projects through exhibits, posters and presentations. Their projects represent the capstone of their educational career. You will see that our graduating MSU engineers are ready to lead, create and innovate.

Our capstone programs and Design Day would not be possible without the continued support of our capstone project sponsors who provide both funding and a professional experience for our capstone design teams. We appreciate their generosity and their time.

Please join us for the Design Day Awards Ceremony in Anthony Hall Room 1281 at 1:15 pm when we will honor all of our talented Spartans, the best of the best.

A handwritten signature in black ink, appearing to read "Leo Kempel". The signature is stylized and fluid.

Dr. Leo Kempel

Dean of the College of Engineering
Professor of Electrical and Computer Engineering
Michigan State University

Events Schedule

Friday, May 1, 2015

EVENTS	7 a.m.	8 a.m.	9 a.m.	10 a.m.	11 a.m.	Noon	1 p.m.
Audio Enthusiasts and Engineers		2nd Floor Rm 2228 8:00 a.m. – Noon					
Engineering Student Organizations		1st Floor West Lobby 8:00 a.m. – Noon					
ECE 101 Presentations			2nd Floor 2200 Hallway 9:00 a.m. – Noon				
ECE 410 Presentations			2nd Floor 2200 Hallway 9:00 a.m. – Noon				
EGR 100 Presentations			2nd Floor 2300/2200 Hallway 9:00 a.m. – Noon				
ME 371 Demonstrations			1st Floor Rooms 1230 & 1234 9:00 a.m. - Noon				
ME 412 Competition		1st Floor Room 1252 8:00 a.m. - Noon					
ME 471 Competition		1st Floor Room 1345 8:00 a.m. - 11:00 p.m.					
ME 478 Presentations			1st Floor West Main Lobby/Stairwell 9:00 a.m. - 10:00 a.m.				
ME 491 Presentations			1st Floor 1200 Hallway 9:00 a.m. - Noon				
ME 497/MKT 420 Presentations		1st Floor Room 1240 8:00 a.m. - 11 a.m.					

CAPSTONE COURSES							
All Capstone Posters for most projects, including BE485/487, ChE 434 and MSE 466		1st Floor 1300/1200 Hallway & 1100 Lobby 8:00 a.m. - Noon for most MSE 466 will be on 2nd Floor Room 2320 8:30 a.m. - Noon					
AES 410 Project Presentations		1st Floor Room 1145 8:00 a.m. - 12:30 p.m.					
CE 495 Project Presentations		First & Third Floors – Rooms 1538, 3400 & 3540 8:00 a.m. - Noon					
CSE 498 Project Presentations		3rd Floor, Room 3405 7:30 a.m. - Noon					
ECE 480 Project Presentations		2nd Floor Rooms 2205 and 2250 8:15 a.m. - 11:25 p.m.					
ME 481 Project Presentations		1st Floor 1200 Hallway/Rooms 1202, 1208 & 1220 from 8:30 a.m. - Noon					

OPENING AND AWARDS							
High School Opening			1st Floor Anthony, Room 1279 8:00 a.m. - 8:40				
High School Award			1st Floor Anthony, Room 1279 12:15 p.m. - 12:30 p.m.				
MSU Awards			1st Floor Anthony, Room 1281 1:15 p.m. - 2:00 p.m.				



Social Media Links:

"Like" the College: <https://www.facebook.com/SpartanEngineering> "Follow" the College: https://twitter.com/msu_egr_news

To stay up to date w/Careers in Engineering:

"Like" Us <http://www.facebook.com/pages/The-Center-for-Spartan-Engineering/226159694117936>

"Follow" Us: <https://twitter.com/msuengineer>

1st Floor Engineering

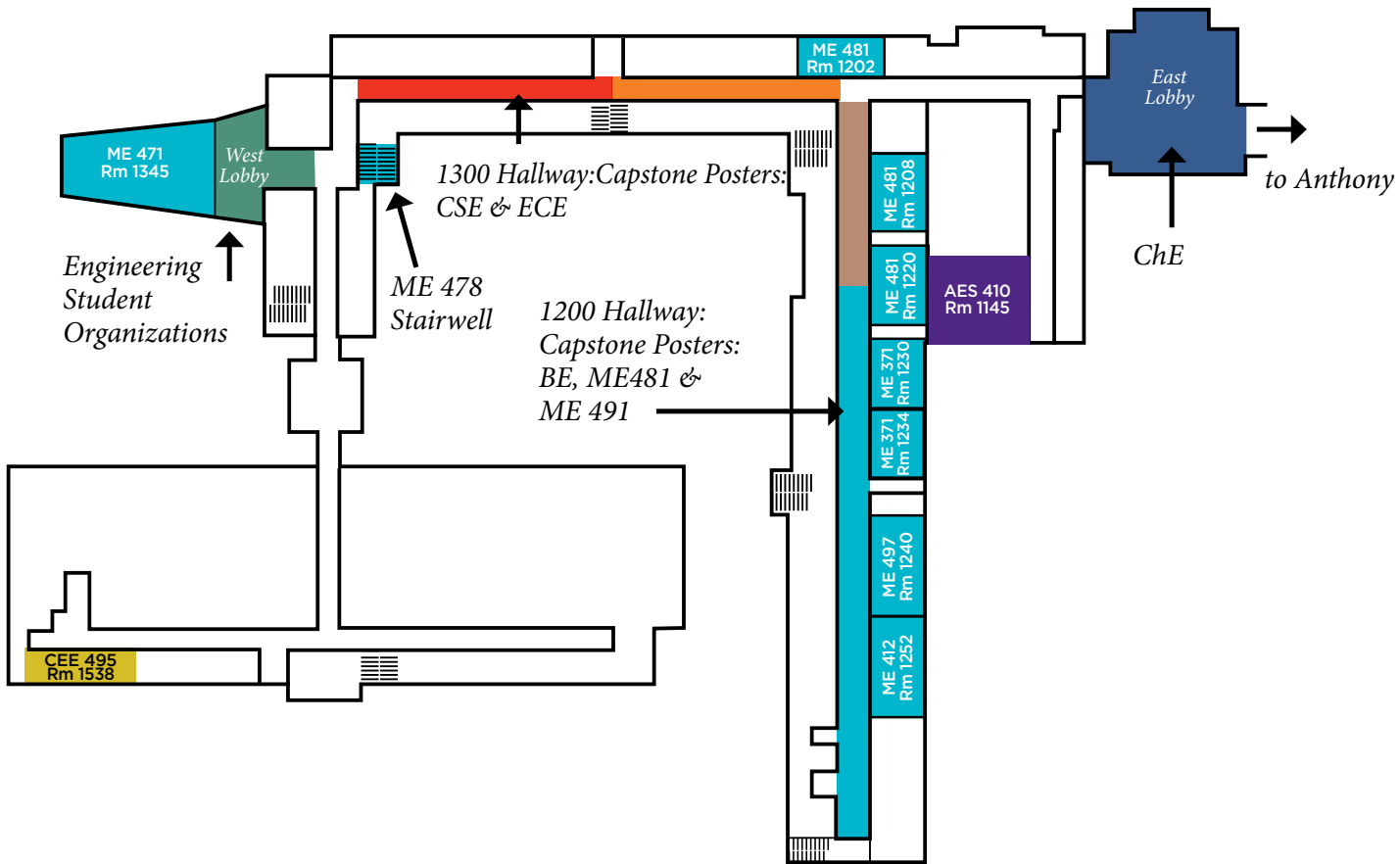

2nd Floor Engineering

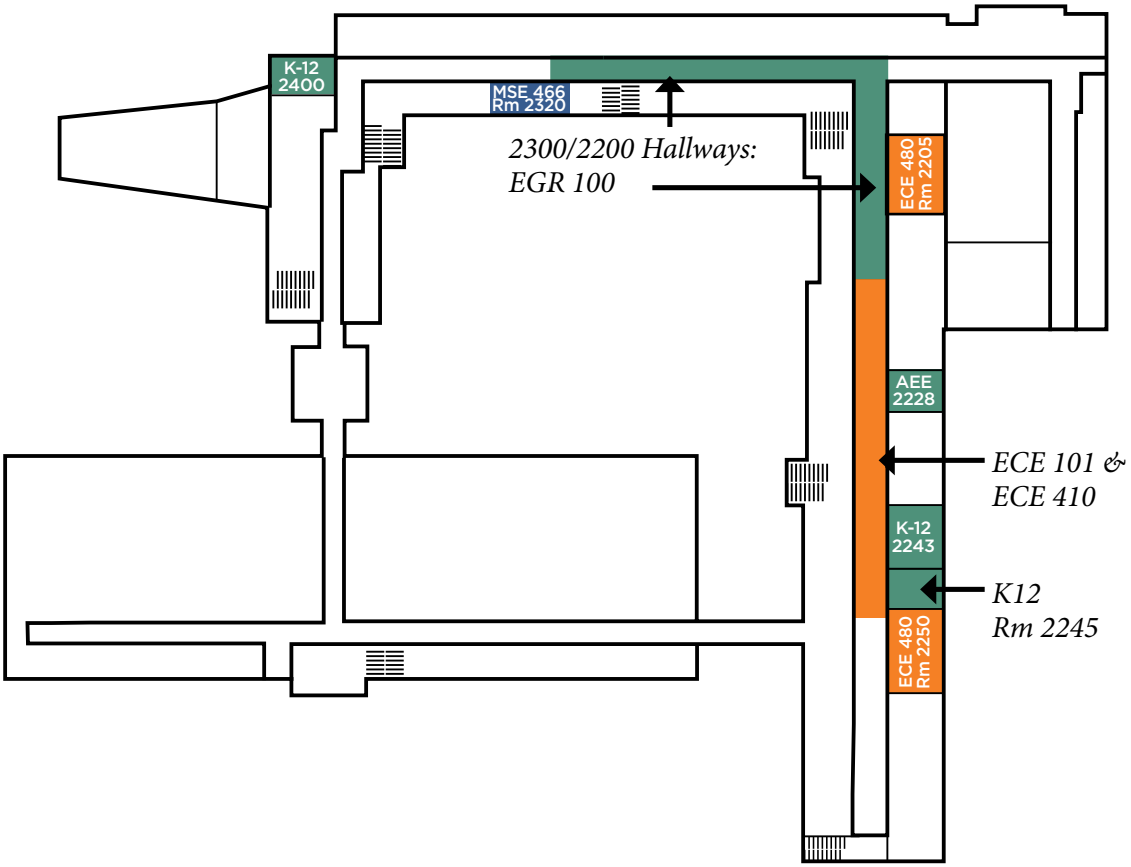

Overview

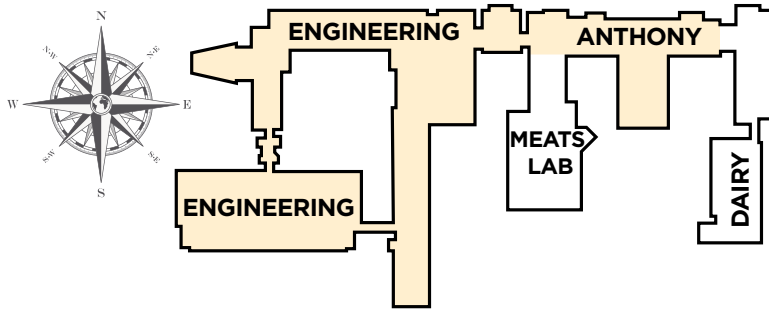

Design Day Floor Plans of the MSU Engineering Building

1st Floor Anthony

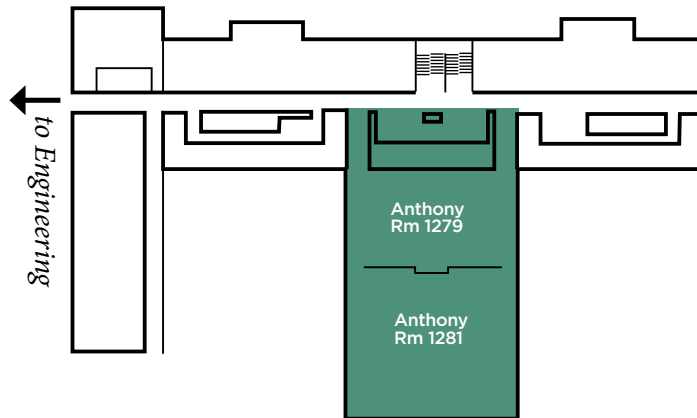

Color Legend:

■ AES	■ CSE
■ BAE	■ ECE
■ CEE	■ ME
■ ChE & MSE	■ Joint/ Other

3rd Floor Engineering

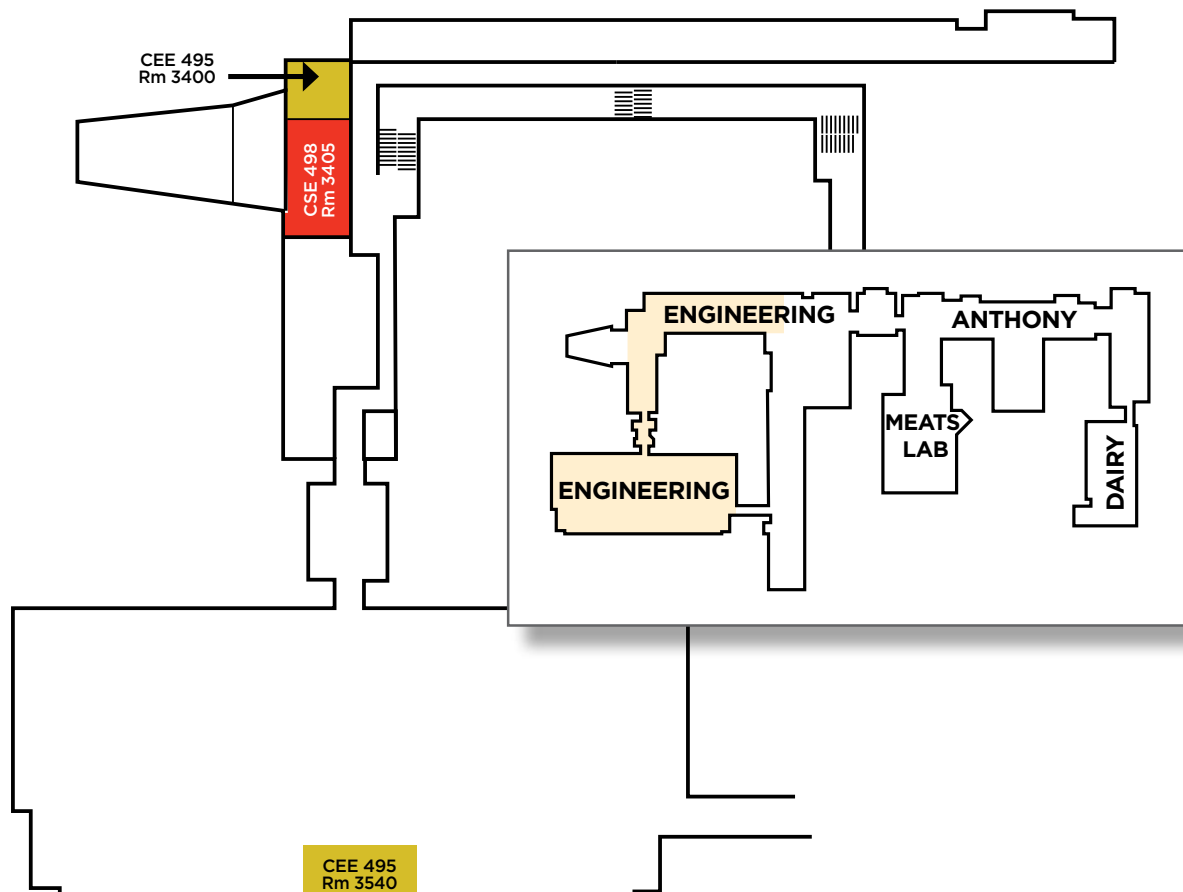



Dart Day of Innovation and Creativity *for 7th-12th Grade Students*



Our Future Lies in Some Very Precious Hands...

At the Dart Foundation, we are committed to developing scientifically literate students in Michigan. We're proud to sponsor the MSU College of Engineering Design Day for pre-collegiate students.

Funded by the Dart Foundation



MICHIGAN STATE UNIVERSITY | College of Engineering

The Dart Foundation

Middle and High School Innovation and Creativity Day

Precollege Student Voting: During the morning on Design Day all visiting precollege students will be viewing Engineering Projects and voting.

During this time college students will have a chance to interact with “non-engineering” students and demonstrate the underlying principles from their projects. This interaction allows the college students an opportunity to practice explaining engineering concepts to non-engineers. As the precollege students work their way through the wide variety of presentations, they will get an overview of the many different branches of engineering. Additionally, as the precollege students see both entry-level and advanced engineering applications, it allows them to see the natural progression of engineering. Lastly, this session also provides a chance for the precollege students to interact with student organizations within the College of Engineering.



Office for Inclusion
and Intercultural Initiatives



	Room 1279 Anthony Check in	C.E./M.E. Team Build Room 2245	VEX Robotics Room 2400	1st & 2nd Floor Voting/ project viewing	Center for Highway Pavement Preservation Room 2243
8:00–8:40	All Schools 1 thru 8				
8:40–9:30		Schools 1 & 2	Schools 5 & 6	Schools 3 & 4	Schools 7 & 8
9:30–10:20		Schools 7 & 8	Schools 1 & 2	Schools 5 & 6	Schools 3 & 4
10:20–11:10		Schools 3 & 4	Schools 7 & 8	Schools 1 & 2	Schools 5 & 6
11:10–12:00		Schools 5 & 6	Schools 3 & 4	Schools 7 & 8	Schools 1 & 2
12:15–12:30	All students in Room 1279 Anthony for the awards ceremony. Lunch will immediately follow.				

<http://www.egr.msu.edu/future-engineer/> LIKE US: <https://www.facebook.com/futurespartanengineers>

UNIVERSITY TRANSPORTATION CENTER FOR HIGHWAY PAVEMENT PRESERVATION (CHPP)

The need to protect the massive national highway infrastructure investment is recognized by Congress and clearly cited in the “Moving Ahead for Progress in the 21st Century Act” or the “MAP-21.” The establishment of CHPP is consistent with the U.S. Secretary of Transportation’s strategic goal of “State of Good Repair.” The mission of CHPP is aimed at providing a new platform for accelerating innovation in highway pavement preservation. The center will assist in meeting the increasing

demand for highway pavement preservation research and will further the goal of increasing the reliability and performance of the nation’s highways. Encouraging the best and brightest future engineers pursuing degrees and careers in transportation-related engineering disciplines should be a big priority. This CHPP session will center on showcasing innovative, creative, and fun challenges, as well as opportunities for participating high school students and teachers.

VEX ROBOTICS

Our team of experts has designed a lab experience to give precollege students an introduction to robots. Students will work in small groups and have a hands-on approach learning to control the VEX robot. They will write programs using Robot C language, and they will program the robot to be controlled by a remote control. Application and discovery of how programming works will be similar to lessons presented in science and math classes. Each team will discover how to adjust their programs based upon the program inputs and actual output (robot performance). During each phase, new challenges will be introduced to engage the students. This will reinforce new ideas and concepts while exposing students to the newly emerging capabilities of student-controlled robotics programs.

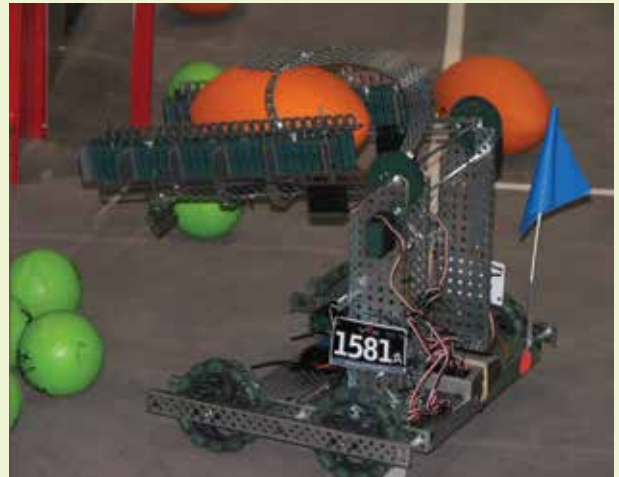

INTERDISCIPLINARY ENGINEERING BUILD

In this build you and your team will be integrating practices from multiple fields of engineering to build and evaluate a support system. Support systems can range from simple beams to intricate bridges composed of gussets, trusses, cables, etc. These types of systems are used throughout Civil, Mechanical and Structural Engineering works. This session will start with a brief introduction to the forces and stresses that act on support systems. Additionally, you will see how digital sensors can read and convey data about these stresses to a computer. We will also look at the computer code that takes this raw data and converts it into a format that can easily be interpreted.



During the build portion of this session you and your team will be given the design constraints for the structure. Utilizing the information learned at the start of the session and the limited materials provided, your team will need to design and then construct a model to be tested. Your finished structure will be placed on one of our

test beds for evaluation. With the help of MSU Engineering students, the results will be collected by a sonic ranging sensor. These data points will be interpreted by the computer program and your team will be evaluated on percent deflection of your support. Throughout this session you will need to listen, learn and utilize your team to be successful. Good Luck.

MEMBERS OF THE ORGANIZING COMMITTEE SPRING 2015



Drew Kim
MSU Engineering
Assistant to the Dean
Recruitment,
Scholarships, and K-12
Outreach



Dean Buggia
Instructor and
Technology
Teacher, Okemos
High School



Luis Donadoto
Assistant
Director of MSU
Engineering
Recruitment and
K-12 Outreach



Rachel Esch
K-12 Outreach
Secretary



Alexandria Fisher
K-12 Outreach
Design Student
Coordinator



Bob Watson
MSU Engineering
K-12 Outreach
LEGO and
VEX Robotics
Coordinator



Imen Zaabar
UTC Faculty and
Outreach Team



EGR 100 Introduction to Engineering Design

Mr. Timothy Hinds
Academic Director

Course Project

EGR 100, Introduction to Engineering Design, is a college-level course required of all incoming first-year engineering students. It is an integral part of the CoRe (Cornerstone and Residential) Experience. The course introduces students to the engineering profession and the engineering design process through team-based, interdisciplinary design projects and assignments. There are 708 students enrolled in EGR 100 this semester.

For the final course project, the student teams selected from ten project types: (i) Solar Car Competition, (ii) Cell Phone App Inventor, (iii) Solar Water Heater Design, (iv) MSU Resource Center for Persons with Disabilities (RCPD) Adaptive Designs, (v) MSU Residential Hall Waste Reduction Designs, and (vi) CoRe industry-sponsored Projects. There were two RCPD projects including Basic Electronics Assistive Tools and Assistive Tools for Middle School Math Instruction. CoRe industry-sponsored projects included a collaboration with ArcelorMittal on Overhead Crane Rail Conflict Avoidance System Design and a Delphi partnered Autonomous Vehicle Development Design. Teams from each of the project types will display their prototypes at Design Day along with posters detailing their design concepts.



Solar Water Heater Design



Basic Electronics Accessible Instruction Module

Fall 2014 EGR 100 Project Poster Award Winners:

l-r: Pat Walton,
Declan McClintock,
Lexi Rogien,
Tim Hinds,
Leo Kemple
Not pictured:
Alexa Bayliss,
Spencer Trimble



<http://www.egr.msu.edu/core/>

Ford Community Corps
ArcelorMittal
Resource Center for Persons with Disabilities
UNION PACIFIC
Consumers Energy
Count on Us
RISE
Michigan State University - Engineers Without Borders
DELPHI
GE
BOSCH
Invented for life
PECKHAM
QUALITY-DIVERSITY-PERFORMANCE
MICHIGAN STATE UNIVERSITY | Residential College in the Arts and Humanities

Intrepid.

Join a team that never backs down - we've earned a reputation for overcoming the most daunting IT challenges.

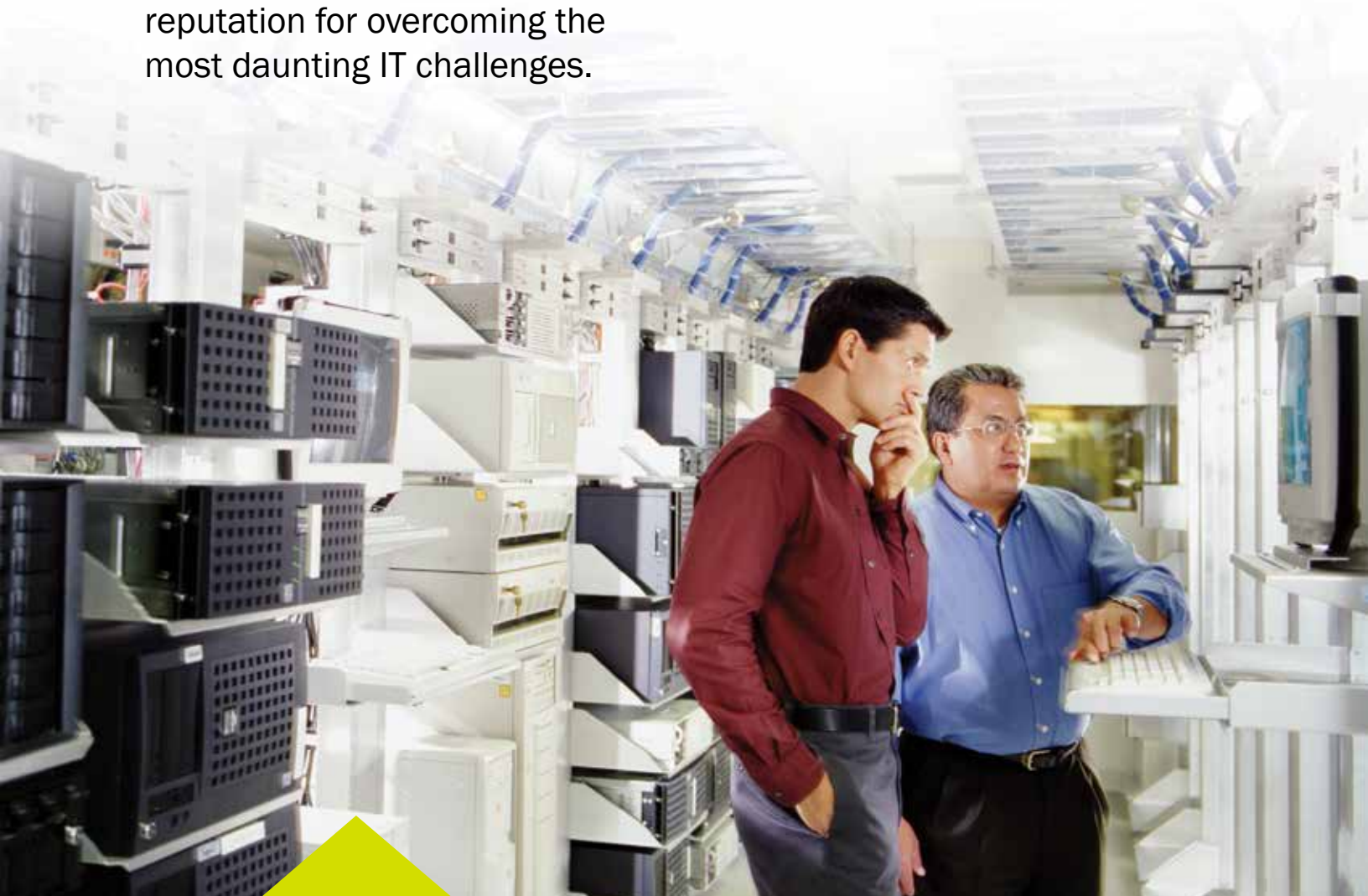

Dare today, to be even better tomorrow

We challenge everyone here at Blackstone to be ambitious about their personal and career goals. If you work for us, we want you to win. We dare you to break out of where you are now and move to the top of the IT industry. We'll be right there with you, helping you take your career as far as you want it to go. Your IT management/technology career will be as important to us as it is to you.

Learn more at bstonetech.com/join-our-team

Applied Engineering Sciences

Capstone Course Sponsors

Dr. Philip L. Fioravante, alumni (BS '84) of our program, winner of the 2004 AES Distinguished Alumni Award and the 2013 College of Engineering Claud R. Erickson Distinguished Alumni Award, is the 2015 sponsor for Applied Engineering Sciences Capstone Awards. Winners are determined based on both final written project reports and on oral presentations at Design Day. We thank Dr. Fioravante for his generous and continuing support of the AES Design Day awards event.

Capstone Project Sponsors and Award Sponsor

**Asahi Kasei
Plastics**
Fowlerville,
Michigan



BASF
Wyandotte,
Michigan



**The Boeing
Company**
Seattle,
Washington



**Consumers
Energy
Company**
Jackson, Michigan



**Continental
Automotive
Systems**
Auburn Hills,
Michigan



**Ford Motor
Company**
Dearborn,
Michigan



GE Aviation
Grand Rapids,
Michigan



**MSU Office of
Sustainability**
East Lansing,
Michigan



We gratefully acknowledge Jim Manely and the Demmer Center for Business Transformation at Michigan State University for their guidance and assistance with our projects. We gratefully acknowledge Judy S. Jacobs, Director, Corporate & Student Relations Office, Michigan State University, Department of Supply Chain Management for her assistance in securing projects. We thank our sponsors for their generous support of the Applied Engineering Sciences senior capstone course.

Applied Engineering Sciences



Dr. Laura J. Genik
 Director of Applied
 Engineering Sciences



Dr. Srinivas (Sri) Talluri
 Professor of Operations
 and Supply Chain Management



Zachary Arritt MBA (2015)
 Supply Chain Management
 The Eli Broad Graduate
 School of Management



Dmitri Alexandrov MBA (2016)
 Supply Chain Management
 The Eli Broad Graduate
 School of Management

Presentation Schedule – 1st Floor, Room 1145

Time	Company	Project Title
8:00 a.m.	Ford	Planning Part Complexity Management in Automotive Manufacturing
8:20 a.m.	MSU Office of Sustainability	Spartan Treasure Hunt – Finding Energy Efficiency through Occupant Engagement
8:40 a.m.	Continental Automotive Systems	Benchmarking and Market Assessment for Rear View and SurroundView Camera Systems
9:00 a.m.	Asahi Kasei Plastics	Bulk Truck Capacity Utilization Analysis
9:20 a.m.	MSU Office of Sustainability	Customer Service Process for Recycling and Surplus Department
Break		
9:50 a.m.	Consumers Energy	Optimizing Logistics Transportation Routing and Scheduling
10:10 a.m.	Boeing	Cost Model for Utilizing Recycled Carbon Fiber in a Paper-making Process
10:30 a.m.	BASF	Master Logistics Plan – Wyandotte, Michigan
10:50 a.m.	MSU Office of Sustainability	Spartan Treasure Hunt – Finding Energy Efficiency through Occupant Engagement
11:10 a.m.	MSU Office of Sustainability	Customer Service Continuous Improvement for Recycling and Surplus Department
11:30 a.m.	GE Aviation	Distribution Model for Raw Materials in the Aerospace Electronics Manufacturing Industry
11:50 a.m.	MSU Office of Sustainability	Optimization of Water Usage on Campus through Data Collection and Analysis
12:10 p.m.	MSU Office of Sustainability	Spartan Treasure Hunt – Finding Energy Efficiency through Occupant Engagement

AES 410 Capstone Course Senior Capstone Project

The culmination of course work in engineering and business, the Capstone course for Applied Engineering Sciences focuses on a semester-long project from a sponsor (industry or non-profit) typically at the confluence of modern business operations and engineering or technical issues. The course is interdisciplinary with Supply Chain Management.

Ford Motor Company

Planning Part Complexity Management in Automotive Manufacturing

Ford Motor Company is a world-class automobile manufacturing company, producing a wide range of vehicles across an extensive worldwide distribution network. Our vehicles are manufactured regionally and globally for regional sales as well as for export.

Regional requirements (legal / manufacturing) and customer preference can drive a significant amount of complexity into component design. Exterior mirrors, for example, may feature anywhere from 40 to well over 100 different buildable combinations for one vehicle.

Where this level of complexity occurs, different manufacturing and logistics solutions are devised to handle the complexity. In-Line Vehicle Sequencing (ILVS), Batch Building, Band use of Broadcast Build systems are methodologies used within Ford and our suppliers' plants to manage complexity.

This project seeks to create a tool that can be used to assess and define the optimal way to manage part or component complexity costs into Ford facilities from our production part supplier facilities. The goal for this tool is to identify cost savings and avoidances both in reduced component piece cost and reduced manufacturing costs at Ford adding to the bottom line.



Michigan State University

Team Members (left to right)

Allen Spiewak
Mt. Clemens, Michigan

Bob Beagan,
Manchester, Michigan

Peter Okoniewski
Jackson, Michigan

Shawn Kamm
Reese, Michigan

Project Mentor
Zach Arritt
Appomattox, Virginia

Ford Motor Company

Project Sponsor

Tracy Wilson
Dearborn, Michigan

MSU Office of Sustainability

Spartan Treasure Hunt – Finding Energy Efficiency through Occupant Engagement

MSU Sustainability values student interaction, creating a positive student experience, offering opportunities for students to gain real-world experience and access to professional staff, creating a connection to academic departments, and approaching projects from a student-focused perspective.

The Spartan Treasure Hunt (STH) project is to create a process to measure the ROI of our Spartan Treasure Hunt program which is focused on energy efficiency and occupant engagement. The project team will learn about the project, understand the intended outcomes and work to develop a process by which MSU can measure the economic, energy, and social impacts. This project will work to answer the questions: “Is the investment in the project worth the outcome? Is the expense of both time and money generating valuable results?”

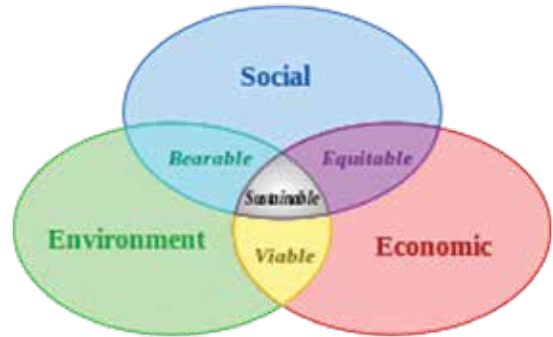

Michigan State University

Team Members (left to right)

Howard Liou
Troy, Michigan

Kyle Sims
Monroe, Michigan

Patrick Kurtz
Lombard, Illinois

Ben Roberts
Laingsburg, Michigan

Gordon Ewald
Laingsburg, Michigan

Project Mentor
Dmitri Alexandrov
Moscow, Russia

MSU Office of Sustainability

Project Sponsor

Jason Vallance
East Lansing, Michigan

Continental Automotive Systems ADS Business Unit Benchmarking and Market Assessment for Rear View and SurroundView Camera Systems

The impact of this project will be to increase and accelerate market knowledge for the Rear View and SurroundView Camera Systems that Continental Automotive Systems ADAS BU is developing, and by doing so, help position Continental to become a leader in supplying such systems to the NAFTA market. We hope to better understand both our competition and our customers at the end of the project. In phase 1, the team will identify key design criteria existent in the current market for both Rear View and SurroundView Camera Systems for automotive applications. In phase 2, the team should identify alternatives for product positioning for all rear and “360-degree” / SurroundView Systems. The desired result from this phase is to prioritize a development path that fits these parties. Any system architecture direction, preferences for security / safety / comfort / convenience features, and preferred new features or functions that are wanted / needed should be captured / defined.



Michigan State University

Team Members (left to right)

Jacob Ripberger
Chelsea, Michigan

Ryan Wrench
Grand Rapids, Michigan

Marty Ophoff
Waterford, Michigan

Kelvin Tsai
Pontiac, Michigan

Zhencen Li
Shenzhen, China

Project Mentor
Zach Arritt
Appomattox, Virginia

Continental

Automotive Systems

Project Sponsor

Dean McConnell
Auburn Hills, Michigan

Asahi Kasei Plastics

Bulk Truck Capacity Utilization Analysis

Currently Asahi transports 30% of their finished products using bulk trucks. A typical bulk truck can hold up to 48,000 lbs of material. They have a fleet of around 35 bulk trucks at their disposal. Each truck is dedicated to a family of products. With an increase in volumes over the past four years, there has been a constraint on the availability of the bulk trucks.

This project did:

- Map the current bulk truck usage,
- Evaluate alternative options that are available in the marketplace,
- Optimize the scheduling of the bulk trucks, taking into consideration the customer demand, driver hours, transit time and other variables, and
- Propose capital investments (if necessary) to increase fleet utilization and increase customer satisfaction.



Michigan State University

Team Members (left to right)

Timothy Jacque
Mount Pleasant, Michigan

Brad Noorman
Grandville, Michigan

Nathaniel Ross
Grand Ledge, Michigan

Jeff Jorgensen
Hudsonville, Michigan

Project Mentor
Zach Arritt
Appomattox, Virginia

Asahi Kasei Plastics

Project Sponsor

Ramesh Iyer
Fowlerville, Michigan

MSU Office of Sustainability

Customer Service Process for Recycling and Surplus Department

MSU Sustainability values student interaction, creating a positive student experience, offering opportunities for students to gain real-world experience and access to professional staff, creating a connection to academic departments, and approaching projects from a student-focused perspective.

This project team will work directly with MSU Sustainability's recycling and surplus department with regard to customer service. The department has begun to develop a customer service program, responding to the university's directive to provide exceptional customer service to all customers. The project will work to create a system that not only tracks customer service but also works on methods to report those results to internal and external audiences, interprets findings, and works for continuous improvement.



Michigan State University

Team Members (left to right)

Nawar Dimitry
Southfield, Michigan

Cary Parvin
Rochester, New York

Kammi England
Pickerington, Ohio

Adam Taglauer
Midland, Michigan

Project Mentor
Zach Arritt
Appomattox, Virginia

MSU Office of Sustainability

Project Sponsor

Ann Erhardt
East Lansing, Michigan

Consumers Energy Company

Optimizing Logistics Transportation Routing and Scheduling

Consumers Energy's internal logistics system includes transportation routes across the State of Michigan to/from approximately 40 company sites. Routes and schedules should be evaluated to determine the most efficient and cost-effective method. This project should result in cost savings in terms of fuel, mileage, and time savings without impacting service levels. The goal is to review the entire logistics transportation network to find areas of improvement, including efficiency, reduction in waste, and optimization of services offered. In addition, the project team should review two other scenarios for cost savings opportunities resulting from the consolidation of (3) material distribution warehouses into (2) locations, as well a potential consolidation into a single distribution center.

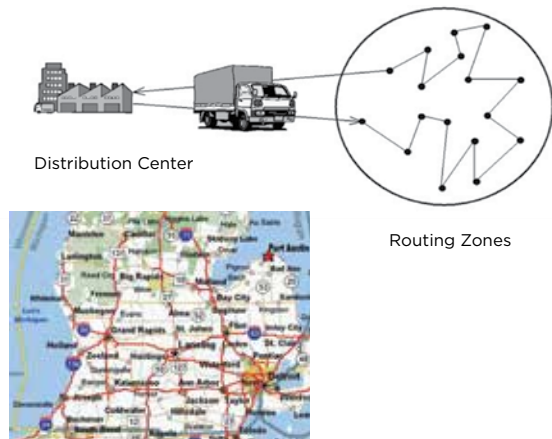

Michigan State University

Team Members (left to right)

Ben Schultz
Tecumseh, Michigan

Madison Miller
Muskegon, Michigan

Anthony Polinori
Muskegon, Michigan

Jacob Magnusson
Plymouth, Michigan

Salim Al-Shatel
Muskegon, Michigan

Project Mentor
Zach Arritt
Appomattox, Virginia

Consumers Energy

Project Sponsors

Jennifer Dreffs
Jackson, Michigan

Chip Johnstone
Jackson, Michigan

The Boeing Company

Cost Model for Utilizing Recycled Carbon Fiber in a Paper-making Process

The purpose of this project is to look at the economic value of recycled carbon fiber with uniformly dispersed matrix which has been made into random mats using wet lay, day lay or paper/mat making processes.

Production of carbon fiber is forecasted to increase in the coming years with its applications continuing to grow in aerospace and automotive industries. With the increase in usage, the quantity of scrap carbon fiber from manufacturing and end-of-life will also increase in the coming years.

Several solutions are available to recover carbon fiber from its various forms uncured prepregs and tapes, fabrics, dry fiber to cured laminates. These solutions include pyrolysis which involves recovering the fiber through elevated temperature and in the absence of oxygen. An alternative is solvolysis which relies on chemicals at high temperature and high pressures to recover the fiber and resin.

The recovered fiber from these processes, combined with thermoplastic matrix filaments, can be used in applications such as dry lay carding and papermaking processes to make random mats which can be molded into composite parts. This team will focus on taking recycled fiber from various sources and modeling the cost of processing the fiber through these processes. The results, coupled with engineering design data, can be used to compare the mats with other materials to determine the economic position in the market.



Michigan State University

Team Members (left to right)

Mike McClafferty
Pigeon, Michigan

Evan Lenz
Ludington, Michigan

Luke Voelker
Pigeon, Michigan

Joshua Smith
Farmington, Michigan

Dillon Drayer
Clarkston, Michigan

Project Mentor
Dmitri Alexandrov
Moscow, Russia

Boeing

Project Sponsors

Hardik Dalal
Seattle, Washington

Pete George
Seattle, Washington

BASF Corporation

Master Logistics Plan - Wyandotte, Michigan

The goal of this project is to create a new master logistics plan for the BASF Wyandotte site. The BASF Wyandotte site is one of the largest BASF sites in North America with 1,200+ employees in manufacturing, administration and Research and Development. The site has approximately 40,000 inbound shipments and 26,000 outbound shipments per year, in addition to having inbound and outbound rail shipping.

The new master logistics plan will include a new truck check-in area, new security center building, new small package receipt and mailroom, new truck driver and contractor orientation center, new truck inspection rack, parking lots and existing assets on the site.



Michigan State University

Team Members (left to right)

Derrick Holifield
Detroit, Michigan

Jaaron Summers
Benton Harbor, Michigan

Nicole Heinz
Northville, Michigan

Brandon Pereira
Big Rapids, Michigan

Dave Tran
Holland Michigan

Project Mentor
Dmitri Alexandrov
Moscow, Russia

BASF Corporation

Project Sponsor

Gary Price
Wyandotte, Michigan

MSU Office of Sustainability

Spartan Treasure Hunt – Finding Energy Efficiency through Occupant Engagement

MSU Sustainability values student interaction, creating a positive student experience, offering opportunities for students to gain real-world experience and access to professional staff, creating a connection to academic departments, and approaching projects from a student-focused perspective.

The goal of this project is to analyze plug load for campus office spaces and construct an ideal workspace that can provide the maximum amount of energy and cost savings. The result of the project should be a recommendation on how to implement and equip energy efficient office space.



Michigan State University

Team Members (left to right)

Liyin Sun
Shanghai, China

Menghua He
Shanghai, China

Leland Padilla
Bloomfield Hills, Michigan

Gavin O’Gara
Sterling Heights, Michigan

Michael Wynne
Grosse Pointe, Michigan

Project Mentor
Dmitri Alexandrov
Moscow, Russia

MSU Office of Sustainability

Project Sponsor

Ann Erhardt
East Lansing, Michigan

MSU Office of Sustainability Customer Service Continuous Improvement for Recycling and Surplus Department

MSU Sustainability values student interaction, creating a positive student experience, offering opportunities for students to gain real-world experience and access to professional staff, creating a connection to academic departments, and approaching projects from a student-focused perspective.

This project team will work directly with MSU Sustainability's recycling and surplus department with regard to customer service. The department has begun to develop a customer service program, responding to the university's directive to provide exceptional customer service to all customers. The project will work to create a continuous improvement process on customer service.

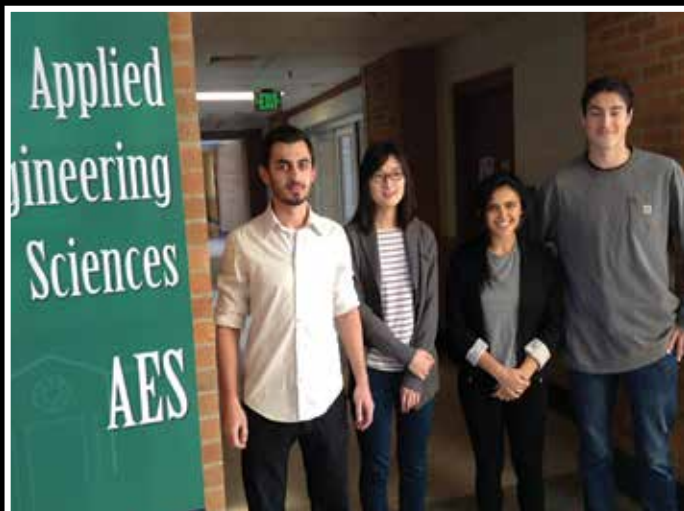

Michigan State University

Team Members (left to right)

Mousa Bokhamseen
Al-hasa, Saudi Arabia

Yuanyuan Liu
Jiangsu, China

Tamara Yassin
Sharjah, UAE

Nate Boddy
Grand Rapids, Michigan

Project Mentor
Zach Arritt
Appomattox, Virginia

MSU Office of Sustainability

Project Sponsor

Ann Erhardt
East Lansing, Michigan

GE Aviation

Distribution Model for Raw Materials in the Aerospace Electronics Manufacturing Industry

Each of the seven GE Aviation electronic manufacturing sites currently has its own supply chain fulfillment model in place. GE Aviation desires to develop a standard solution for raw material fulfillment into each of these manufacturing sites. Potential solutions to this challenge could include but are not limited to: developing a distribution center model, utilizing a 3rd party logistics provider, implementing a vendor manage inventory system, or centralizing the Sourcing function. GE Aviation would like this project to include a benchmarking exercise of the best in class organizations in electronics fulfillment. The new model must allow GE Aviation to reduce overhead costs at each site, leverage increased spend volume, improve inventory turns, and allow for a higher on-time delivery performance to each of the GE Aviation sites.



GE
Aviation



Michigan State University

Team Members (left to right)

Luyi Han
Shanghai, China

David Hill
Clinton Twp, Michigan

Je'Qua Halliburton
Detroit, Michigan

Cameron Canady
Dearborn, Michigan

Michael Delaney
South Lyon, Michigan

Project Mentor
Dmitri Alexandrov
Moscow, Russia

GE Aviation

Project Sponsors

Tom Pykosz
Grand Rapids, Michigan

Tyler Zimmer
Grand Rapids, Michigan

MSU Office of Sustainability

Optimization of Water Usage on Campus through Data Collection and Analysis

MSU Sustainability values student interaction, creating a positive student experience, offering opportunities for students to gain real-world experience and access to professional staff, creating a connection to academic departments, and approaching projects from a student-focused perspective.

The project focuses on research into data collection and reporting methods of water usage on campus, as well as developing a process by which to collect and share that water usage and quality data. Deliverables include recommendation of key metrics that we should use to analyze the water system.

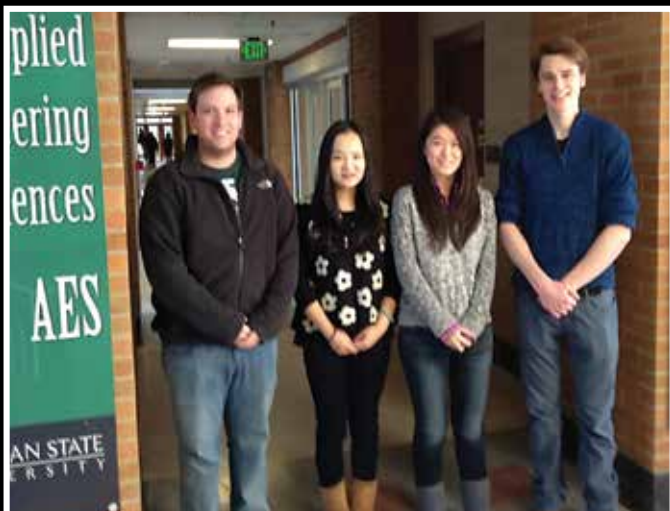

Michigan State University Team Members (left to right)

Spencer Chapman
Lansing, Michigan

Jie Huang
Hangzhou, China

Yuzhu Liu
Wuhan, China

Garrett Bowker
Bay City, Michigan

**Project Mentor
Dmitri Alexandrov**
Moscow, Russia

MSU Office of Sustainability Project Sponsor

Ann Erhardt
East Lansing, Michigan

MSU Office of Sustainability

Spartan Treasure Hunt – Finding Energy Efficiency through Occupant Engagement

MSU Sustainability values student interaction, creating a positive student experience, offering opportunities for students to gain real-world experience and access to professional staff, creating a connection to academic departments, and approaching projects from a student-focused perspective.

The Spartan Treasure Hunt (STH) is to create a process to measure the ROI of our Spartan Treasure Hunt program which is focused on energy efficiency and occupant engagement. The project team will learn about the project, understand the intended outcomes and work to develop a process by which MSU can measure the economic, energy, and social impacts. This project will work to answer the questions: “Is the investment in the project worth the outcome? Is the expense of both time and money generating valuable results?”



Michigan State University

Team Members (left to right)

Jared Grubka
Portage, Michigan

Rui Gong
Guangdong, China

Sarah Niezabytowski
Sterling Heights, Michigan

Wesley Janks
Birmingham, Michigan

Antoine Tillman
Detroit, Michigan

Project Mentor
Dmitri Alexandrov
Moscow, Russia

MSU Office of Sustainability

Project Sponsor

Ann Erhardt
East Lansing, Michigan



HOW CAN PAINT PURIFY THE AIR WE BREATHE?

Simple. Add a monomer to the paint that transforms formaldehyde into harmless vapor, effectively creating a powerful air-purifying shield. That's how science and humanity come together to create solutions for human progress.

A career with us is an invitation to explore, create, and make valuable contributions to bring the world forward. **That's Dow.**



The science to your success.



Visit dow.com for more information on how Dow brings science and humanity together to innovate solutions that enhance the quality of life.

www.careersatdow.com





The only thing more
diverse than our products....
are the people who create them.



Whirlpool Corporation, named by *FORTUNE* magazine as a
Top 10 Global Company for Leaders, offers 9 Leadership
Development Programs for business and engineering graduates.

For more information about our full-time and
internship programs, visit:

www.WhirlpoolCareers.com





Dr. Dana Kirk, PE
Asst. Professor

**Department of
Biosystems & Agricultural
Engineering**



Dr. Luke Reese
Assoc. Professor

**Department of
Biosystems & Agricultural
Engineering**

About the Program

The Biosystems Engineering (BE) undergraduate program prepares graduates who will integrate and apply principles of engineering and biology to a wide variety of globally important problems. To achieve that purpose, the primary objectives of the BE program are to prepare graduates to:

- Identify and solve problems at the interface of biology and engineering, using modern engineering techniques and the systems approach, and
- Analyze, design, and control components, systems, and processes that involve critical biological components.

Additionally, the Biosystems Engineering program is designed to help graduates succeed in diverse careers by developing a professional foundation that includes vision, adaptability, creativity, a practical mindset, effective communication skills for technical and non-technical audiences, the ability to work in diverse, cross-disciplinary teams, and a commitment to sustainability, continuing professional growth, and ethical conduct.

BE 485 / BE 487 Courses

Biosystems Engineering student teams, enrolled in the two-semester biosystems design capstone experience, BE 485/487, develop, evaluate, and select design alternatives in order to solve real-world problems. Projects are diverse, but each reflects systems thinking by integrating interconnected issues affecting the problem, including critical biological constraints. The engineering design process is documented in a detailed technical report. Teams present project designs to engineering faculty and a review panel of professional engineers for evaluation. Each BE 485/487 capstone design team prepares and presents a design solution in report, poster and oral formats to industry, faculty, peers and the public that:

- Requires engineering design
- Combines biology and engineering
- Solves a real problem
- Uses a holistic approach
- Interprets data
- Evaluates economic feasibility

Industry Advisory Board & Project Evaluators

The purpose of the Industry Advisory Board is to facilitate the exchange of ideas between Board members, faculty, and students of the BE program. Its function is to improve continuously the BE program quality by keeping it current and relevant to industry needs. Regular and adjunct board members also serve as external project evaluators.

Board

Ms. Lisa Buchholz - Dow AgroSciences
Ms. Michelle F. Crook, PE - MDA, Envir. Stewardship Div.
Mr. Cassandra Edwards - ConAgra Foods
Mr. Bryce Feighner, PE - MDEQ
Mr. Gene Ford - Nestlé Nutrition
Mr. Andrew Granskog, PE - USDA-Rural Development
Ms. Ashley Julien - Tetra Tech
Mr. Andrew Knowles - JBT FoodTech
Mr. Jeffrey Mathews, PhD - PepsiCo Global Beverage R&D
Mr. Mitch Miller - General Mills-Yoplait
Mr. Dave Prouty - Heat Transfer International
Mr. Steve Richey - Kellogg
Mr. Steve Steffes, PE - Perrigo

Mr. Larry D. Stephens, PE - Stephens Consulting Serv., P.C.
Mr. Muluken Tilahun - Kraft Food
Mr. Richard Woodford, PE - USDA-NRCS

Project Evaluators

Mr. Ralph Elias - Terumo Cardiovascular Systems
Mr. Bob Ellerhorst, PE - MSU Power Plant
Ms. Danielle Habitz - Kellogg
Mr. Tim Krause, PE - Granger
Mr. Steve Mohr
Mr. Keith Tinsey - Walther Farms
Mr. Nick Tipper - Techmark

Integrating Water and Energy Engineering with Ecotourism in a Costa Rican Aboriginal Community

Sponsor – EPA
Faculty Advisor – Dr. Dawn Reinhold
Industry Evaluators – Mr. Larry Stephens, PE & Mr. Rick Woodford, PE



Team “Shuabb Systems” has designed an integrated system to provide potable water, wastewater treatment, and energy production for an ecotourism project led by the Shuabb Aborigine Women Association in Costa Rica. By integrating green technologies such as water filters, anaerobic digestion and constructed treatment wetlands, the project aims to secure clean water for human consumption and treat solid waste and wastewater, while creating renewable energy on site. The project is in cooperation with the Gender Equity Office from the Technological Institute of Costa Rica, and can demonstrate the economic value of such development in a region with limited access to public services.



(L to R) Gina Masell, Nicole Kruse & Brian Smith

Optimizing Wastewater Irrigation for Food Industry Application

Sponsor – Major Food Manufacturer
Faculty Advisors – Dr. Steve Safferman, PE & Mr. Steve Miller, PE
Industry Evaluators – Ms. Lisa Buchholz, Mr. Nick Tipper & Mr. Keith Tinsey

The purpose of this project is to identify and address problems encountered in the center pivot irrigation wastewater treatment process of a food production company. This project uniquely combines aspects of the mechanical, chemical, and biological areas as it looks at refining a process as a whole, rather than just a specific point in the process. It is through providing solutions to the identified problems that the team will deliver supported recommendations to better optimize the current process and improve adherence to standards set forth by the appropriate government agencies.



(L to R) Quincy Brissette, Kyle Guyer & Brody Lawrence

Green Infrastructure Design Project

Sponsor – Tetra Tech
Faculty Advisor – Dr. Pouyan Nejadhashemi
Industry Evaluators – Mr. Andrew Granskog, PE & Ms. Ashley Julien

Project sponsor Tetra Tech is working to reduce stormwater runoff in Detroit in order to mitigate sewer system overflow. Team “Flood Control” is working on a Low Impact Development design to capture and treat runoff at Edison Elementary School.

Best management practices (BMPs) will be introduced to control and limit the flow rate of stormwater runoff entering the sewer system. Stormwater runoff reduction will decrease the amount of raw sewage disposal into local water bodies and have added environmental benefits. Project deliverables include hydrological models proving that BMPs meet project objectives, CAD drawings of BMPs, and a detailed cost analysis of the final design.



(L to R) Alex Whitlow, Chris Ross & Andrew Stoffel

Anaerobic Digestion: A Pre-feasibility Study

Sponsor – Granger
Faculty Advisor – Dr. Dana Kirk, PE
Industry Evaluators – Mr. Bryce Feighner, PE & Mr. Tim Krause, PE



Granger is a waste hauling and landfill gas collection company operating throughout the nation. Granger is interested in increasing power production at its Grand River site, and they believe anaerobic digestion could be a potential solution to generate an additional 600kWh. The “Power Grangers” team is conducting a pre-feasibility study of an anaerobic digester to determine whether it can be implemented into their current system. This study includes the formulation of a feedstock blend for optimal methane production, an anaerobic digester design, a recommended use for the digestate, operational and regulatory challenges, and a complete economic analysis of the overall system.



(L to R) Mariana Madrigal-Martinez, Taylor Folkertsma & Lauren Prochazka

Wastewater Treatment Electrocoagulation

Sponsor – Bellingar Packing
Faculty Advisor – Dr. Wei Liao, PE
Industry Evaluators – Ms. Michelle Crook, PE &
Mr. Mitch Miller



Team “Meat the Spartans” is working with Bellingar packing, a small-scale meat processing facility in St. Johns, Michigan. The team’s objective is to design and construct a system to scale-up to treat 9,000-12,000 gallons of wastewater weekly and comply with MDEQ and EPA discharge standards while producing renewable energy and solid waste fertilizer. The treatment system consists of an anaerobic digester to initiate breakdown of the solids within the wastewater and generate biogas, used to offset natural gas consumed for heating water, followed by an electrocoagulation reactor, which charges solid particles to adhere to one another for easy removal as a concentrated fertilizer.



(L to R) Hannah Pichner, Dimitrius Innis & Andris Grinvalds

Torrefaction of Biomass

Sponsor – Heat Transfer International (HTI)
Faculty Advisor – Dr. Chris Saffron
Industry Evaluators – Mr. Bob Ellerhorst, PE & Mr. Dave Prouty



Greenhouse gas emission regulations are increasing, thus creating demand for practical energy alternatives. An alternative being studied is torrefied woody biomass pucks that can act as “drop ins” for coal plants. The puck hydrophobicity is the focus of the project. In order to achieve hydrophobicity comparable to coal, different alternatives will be analyzed including hydrophobic coating applications, altering the process conditions and a binding agent. A break-even analysis will be conducted in order to determine the necessary cost of a carbon dioxide tax on coal in order for the biomass pucks to be competitive.



(L to R) Lucas Flynn, Xuhao Dai & Mackenzie Tocco

Utilization of Chitosan as a Bio-pesticide Extracted from Sugar Beet Pulp

Sponsor – Michigan Sugar Company
Faculty Advisor – Dr. Yan (Susie) Liu
Industry Evaluators – Mr. Gene Ford, Ms. Danielle Habitz &
Dr. Jeff Mathews



Michigan Sugar produces 25,000 tons of sugar beet pulp per year which is predominately used as a low value animal feed. Due to the increasing competitiveness of sugar beet processing, it is critical to develop a more valuable byproduct. Team “Sugar BE-ets” project goal is to utilize wet sugar beet pulp by applying the biological method of simultaneous saccharification and fungal fermentation to produce chitosan for use as a bio-pesticide.



(L to R) Samantha Walby, Elizabeth Gregory & Andrew Brown

Reducing Spoilage Microorganisms in Cherry Pomace

Sponsor – Food Processor (under Non-Disclosure Agreement)
Faculty Advisors – Dr. Kirk Dolan & Dr. Dan Guyer
Industry Evaluators – Mr. Steve Richey, Mr. Steve Mohr &
Mr. Muluken Tilahun



Team “Microbe Busters” is to create a design to reduce the amount of spoilage microorganisms in cherry pomace, a byproduct of tart cherry juicing, without degrading positive phytochemical attributes of the pomace.

Client deliverables include a design with optimized operation parameters, testing that demonstrates the design solution’s effectiveness, a vendor recommendation, and an economic analysis of operation and capital costs associated with the design.



(L to R) Caleb Bruhn, Kristine Nguyen & Rachel Kurzeja

JBT FoodTech Continuous Freezer Conveyor Belt Cleaning System

Sponsor – JBT FoodTech

Faculty Advisors – Dr. Sanghyup Jeong & Mr. Phil Hill

Industry Evaluators – Ms. Cassandra Edwards & Mr. Andrew Knowles



The “Clean Freeze” team project is to design a continuous, run cold, external belt rinser and drier for a JBT GC M10 Tight Curve spiral freezer. After frozen food product exits the freezer, the system will clean the belt of built-up frost and food debris with an optional allergen abatement method and then completely dry the belt before food is placed on it.

Client deliverables for this project include a mathematical model of the design, a tested prototype design, a full-scale design recommendation, a complete bill of materials, and an economic feasibility analysis.



(L to R) Stephen Jones, Scott Rubin & Danielle Boileau

Wearable Phototherapy Device for Jaundice Treatment

Sponsor – Biosystems and Agricultural Engineering

Faculty Advisors – Dr. Tim Whitehead & Mr. Steve Marquie

Industry Evaluators – Mr. Ralph Elias & Mr. Steve Steffes, PE



Jaundice, or hyperbilirubinemia, is a medical condition that affects approximately 60% of newborns. It is caused by an excessive formation of the product of red blood cell breakdown (bilirubin) in the blood. Current treatments include blue light phototherapy administered in an incubator. This treatment method is expensive and disrupts critical mother and infant bonding time.

A design is proposed for a safe and wearable phototherapy treatment device that prevents the separation of mother and infant. The device is intended to be a portable and affordable treatment method for developing countries where jaundice is prevalent and power sources are limited.



(L to R) Alexis Wloch, Celina Merhi & Sarah Buchholz



BE Showcase - April 16, 2015



Industry Evaluation

If you are interested in sponsoring a BE 485/487 capstone project for the 2016 Senior Design teams, please contact Dr. Dana Kirk at kirkdana@msu.edu or Dr. Luke Reese at reesel@msu.edu.

The Capstone Projects

Faculty Advisors:

Professors Baladi, Haider, Ingle, Kodur, Li, and Masten



Baladi



Haider



Ingle



Kodur



Li



Masten

Presentation Schedule – Rooms 1538, 3400 and 3540

Time	Team	Room
8:00 a.m.	Team One (Phoenix Enterprises)	First Floor Room 1538 EB
9:20 a.m.	Team Two (Terraform Engineering)	First Floor Room 1538 EB
10:40 a.m.	Team Three (Capital City Consulting)	First Floor Room 1538 EB
8:00 a.m.	Team Four (Tower Engineering)	Third Floor Room 3400 EB
9:20 a.m.	Team Five (Allore Enterprises)	Third Floor Room 3400 EB
10:40 a.m.	Team Six (Wilson Consulting)	Third Floor Room 3400 EB
8:15 a.m.	Team Seven (Water Pulse Consulting)	Third Floor Room 3540 EB
9:40 a.m.	Team Eight (Stealth Engineering)	Third Floor Room 3540 EB

CE 495 Senior Design in Civil & Environmental Engineering

Undergraduates in civil and environmental engineering must take CE 495. This capstone course prepares students for the workplace by providing an experience with the following challenges:

- A project with multiple issues that must be resolved using civil and environmental engineering knowledge;
- Formulation of conceptual solutions and resolution of conflicting design elements;
- Development of plans that comply with regulations and provide a basis for cost estimates;
- Balancing individual responsibility and group participation in a team based effort;
- Preparation of written reports and oral presentations.

Each team is responsible for developing a design that addresses environmental, geotechnical, hydrological, pavement, transportation, and structural issues for the project. A student project manager coordinates each team. Design reports are judged by the faculty; progress reports and the oral presentations are judged by a board of practicing professionals.

CE 495 SENIOR DESIGN IN CIVIL & ENVIRONMENTAL ENGINEERING

Michigan State University Mixed-use Development

Student-teams developed preliminary designs for elements of a 29-acre site located west of Marsh Rd. and south of Haslett Road. The site was to be designed as a mixed-use development following the Meridian Township Planned Unit Development (PUD) requirements.

The project development must include a brewery along with both residential and commercial land uses. The objective of this project was to provide Meridian Township Planning Commission with a Preliminary Engineering Design. Major goals were to maximize green space; create a walkable community and ensure pedestrian and bicycle access to the Inter-Urban pathway, local schools, and Meridian Township; to protect as many of the mature trees on-site as possible; and to identify and protect any federally classified wetlands on-site.

TEAM ONE: PHOENIX ENTERPRISES



Back Row, L to R: Tyler Hesse (G), Joseph Kolpasky (P), Daniel Krokker (T), Daniel Domino (WR)
Front Row, L to R: Ryan Austin (E), Anna Strong (PM), Dylan Simmer (S)

TEAM TWO: TERRAFIRM ENGINEERING



Back Row, L to R: Pablo Ramirez (P), Jesse Kenniston (G), Jacob Patin (PM), Matt Helfehein (S)
Front Row, L to R: Bethany Swanberg (E), Samantha Eanes (WR), Ethan Akerly (T)

TEAM THREE: CAPITAL CITY CONSULTING



Front Row, L to R: Alexander Novikov(S), Blake Junak (T), Alex Casabuena (WR), Morgan Hoxsie (PM), Trevor Painter (E), Brian Merk (G), Evan Forgacs (P)

TEAM FOUR: TOWER ENGINEERING



Back Row, L to R: Eric Wahrman (WR), Nick Tower (S), Adam Chludzinski (P), Stefan Kegebein (G)
Front Row, L to R: James Biehl (T), Laura Anderson (PM), Sumer Alstarwah (E)

Key: E = Environmental, G = Geotechnical, P = Pavements, PM = Project Manager S = Structures, T = Transportation and WR = Water Resources

TEAM FIVE: ALLORE ENTERPRISE



Back Row, L to R: Kevin Sullivan (P), Patrick Swiszc (S), Keegan Hall (G), and Erik Allore (PM)
Front Row, L to R: Fatima Abdelwahd (E) Brandon Forsythe (T), and Stephanie Batshon (WR)

TEAM SIX: WILSON CONSULTING



Front Row, L to R: Drake Veitenheimer (S), Joseph Gools (E), Rachel Norman (WR), Matthew Wilson (PM), Andrea Kovacic (P), Linzy Pedersen (T), and Suihan Liu (G)

Michigan State University

Nemoka Drain Project

Student-teams provided Meridian Township and the Ingham County Drain Commissioner with a Preliminary Engineering Design for a 115-acre site located just east of Marsh Road in the vicinity of Haslett Road. Major goals for the project are to prevent flooding in the Nemoka Drain District; improve road conditions, create a walkable community, and ensure pedestrian and bicycle access to nearby schools and the pathway; protect as many of the mature trees on-site as possible; prevent flooding in the Nemoka Drain and scouring of the channel as the water enters. All work is to be done in accordance with local, state, and Federal regulations.

TEAM SEVEN: WATER PULSE CONSULTING



Front Row, L to R: Brett McDonald (P), Jeffrey Huron (WR), Khaled Alghafli (WR), William Seeger (T)

TEAM EIGHT: STEALTH ENGINEERING



Front Row, L to R: Adam Jadun (P), Andrew Meux (T), Amanda Palmer (WR), Tyler Sonoga (WR). Not pictured: Dylan Simmer (S)

Key: E = Environmental, G = Geotechnical, P = Pavements, PM = Project Manager S = Structures, T = Transportation and WR = Water Resources

CE 495 SENIOR DESIGN IN CIVIL & ENVIRONMENTAL ENGINEERING

PROFESSIONAL SEMINAR SPEAKERS

Neeraj Buch Michigan State University	Iman Harsin Michigan State University	Ryan D. Musch, P.E. Fishbeck, Thompson, Carr & Huber	Leah Tapp, P.E., AVS HNTB Corp.	Roy D. Townsend, P.E. Washtenaw County Road Commission
Michele J. Buckler, P.E. Fishbeck, Thompson, Carr & Huber	Cheryl A. Kehres- Dietrich, CGWP Soil & Materials Engineers, Inc.	Robert D. Rayl, P.E. RS Engineering, LLC	Michael Thelen, P.E. Soil & Materials Engineers, Inc.	Mark A. VanPortfleet, P.E. Michigan Department of Transportation
Daniel G. Fredendall, P.E. OHM Advisors	Emin Kutay, P.E. Michigan State University	Charles Rolfe, P.E. OHM Advisors	Daniel Thome, P.E. Nicholson Construction Company	Kelby Wallace, P.E. Michigan Department of Transportation
		Scott K. Stowitts, P.E. Walbridge		

PROFESSIONAL EVALUATORS

Engineers and scientists associated with the following firms, municipalities, and companies donated time to provide students with a practicing professional’s perspective. We gratefully acknowledge their generous contributions.

Len Becker, P.E. HNTB	Tyler Dawson, P.E. NTH Consultants	Matt Junak, P.E. HNTB	George McKenzie, P.E. Consumers Energy	Geneva Vanlerberg, P.E. Lansing Board of Water & Light
Tom Boom, P.E. Barr Engineering Co.	Holly Donoghue, P.E. NTH Consultants	Kelly Karll, P.E. SEMCOG	Doug Skylis, P.E. Rowe PSC	Phillip Vogelsang, P.E. URS Corporation
Rick Chelotti, P.E. Bergman Associates	Lauren Fedak Harley Ellis Devereaux	Therese Kline, P.E. Michigan Department of Transportation	Michael J. Thelen, P.E. Soil & Materials Engineers, Inc.	Lauren Warren, P.E. Parsons Brinckerhoff
Daniel Christian, P.E. Tetra Tech MPS	Tim Greenleaf, P.E. Barr Engineering Co.	Thomas Larder, P.E. Process Results, Inc.	Anthony Thomas, P.E. Soil & Materials Engineers, Inc.	
David Conklin, P.E. Fishbeck, Thompson, Carr & Huber	Andrew Hermiz, EIT Harley Ellis Devereaux	Peter Margules, P.E. NTH Consultants		

Rolla C. Carpenter Senior Design Award

The Rolla C. Carpenter Senior Design Award (\$700 and plaques) is presented to the best team as judged by the faculty and a panel of practicing engineers.

Rolla C. Carpenter, Renaissance Engineer, was a graduate of The State Agricultural College in 1873 with a Bachelor of Science degree. After earning a Master of Science Civil Engineering, he was appointed professor of the Department of Mathematics and Civil Engineering at the State Agricultural College, which would later become MSU. He designed bridges, built ice houses, taught students French, astronomy, mathematics, mechanical drawing, hydrostatics, hydraulics, survey, and civil engineering. He prepared the design and working drawings for the Farm Lane Bridge, laid a water supply pipe to Williams and Wells Halls, and designed a pile driver for a dam built across the Red Cedar River. He later designed several buildings on campus, including the Mechanical Building, which was constructed in 1885. Throughout all of his work on campus, he involved students throughout the analysis, design, and construction, forming what was essentially the first senior capstone design class.



The faculty and students of the Department of Civil and Environmental Engineering gratefully acknowledge the generous contributions from Fishbeck, Thompson, Carr & Huber, Inc. (FTC&H) and Barr Engineering Co.

Process Design and Optimization II



Dr. Martin Hawley
Professor and Chairperson
of Chemical Engineering and
Materials Science



Ms. Chun Liu
Graduate Assistant
Chemical Engineering and
Materials Science

Course Description

ChE 434 is a logical extension of the first semester of chemical engineering senior design. The abilities developed over a wide range of chemical engineering courses are now applied to a problem extending over a somewhat longer period of time; requiring more initiative, enterprise, care and a greater measure of individual responsibility. For the 46th successive year, we have worked the American Institute of Chemical Engineering (AIChE) Student Contest Problem. We use these industry-designed problems for three reasons: 1) they are well-rounded problems, 2) they tell our students and our faculty something about the kind of abilities that industrial companies would like graduating chemical engineers to have, and 3) there is the advantage of seeing how well our students compare with graduates of other universities in a national competition of this quality.

For Design Day, four teams and four individuals were chosen to present their design via a poster presentation. From this final group, two teams of two, and two individuals will be chosen to compete in the national AIChE competition in the fall. Since 1968, about half of the students whose reports rated first or second at MSU also finished among the top six nationally.



Last Year's Winner!

One student who presented at last Spring's Design Day received top honors in the 2014 AIChE National Student Design Competition. Eric Vasko was able to travel to Atlanta in November 2014 to present solutions at the AIChE National Meeting.

AIChE[®]

Michigan State University Alternate Technology for Sour Water Stripping: Natural Gas as a Substitute for Air

The objective of this year's AIChE Design Problem is to design an alternative process for the removal of ammonia and hydrogen sulfide in sour water. This unconventional strategy will then be compared to the traditional technologies that use air stripping. The range of flow and composition of NH_3 and H_2S is given; a sensitivity analysis for the both designs is required. A final design should consider these two options and choose accordingly.

The students are required to design a conceptual block flow diagram accompanied by a process description. The economic analysis must consider the penalty associated with violating an air permit, the tradeoff between natural gas as a treatment option vs. selling the fuel, and a decision to treat the water.



Alexander Renny



Ali Amir



Cale Hyzer



Eric Macciomei



Cory Beck & Elizabeth Williams



Jacob Mackowski & Holly Kuhl



Jarrett Peplinski & Nolan Wreford



Mitchell Reyers & Matthew Schweiger



Senior Capstone Design in Materials Science and Engineering

Dr. Martin Crimp
Professor of Chemical Engineering and Materials Science

Course Description

MSE466 is a senior level course for Materials Science & Engineering majors providing students with a team-based capstone design experience. A major aspect of this course is to have students apply their course-learned background knowledge and skills in materials science and other disciplines to real-life design problems. A failure analysis investigation (FAI) fits this context. Failures are a major motivating factor for promoting more innovative designs or design changes. A failure analysis investigation provides a unique platform to design and to solve real-world engineering problems via a systematic engineering approach. By focusing on a specific design failure, the student teams learn how to confront an open-ended problem that requires them to develop a strategic design plan and to execute the methodology for assessing how and why the failure occurred. The analysis is conducted using established investigative procedures and constraints for conducting failure analysis investigation. This semester, there are seven 3-member teams working on seven real engineering failures.

Successfully completed team projects culminate in a comprehensive written final report and a strategic redesign plan to improve the design and mitigate future failures. For Design Day the teams present their findings in half-hour presentations. For 2015, the seven teams are conducting the following failure analysis investigations:

Presentation Schedule – Second Floor Room 2320

Time	Team	Project
8:30 a.m.	Los Tres Toreros	Aluminum Drive Belt Failure Investigation
9:00 a.m.	No Mow Worries	Mower Deck Mandrel Housing Failure
9:30 a.m.	Save Our Spring	Spring Steel Coil Failure
10:00 a.m.	Fudd	Failure Analysis of a Winchester Model 1200 Gun Barrel
10:30 a.m.	The Big Three	Half-shaft Low-load Torsional Fatigue Failure Analysis
11:00 a.m.	The Breaker Bar-Barians	Breaker Bar Failure Investigation
11:30 a.m.	The Shock Squad	Failure Analysis of Rear Shock Absorber for Electric Bike



(left to right) David Hernandez, Jeff Tatum, Aaron Marietta

Group Name: Los Tres Toreros
Project: Aluminum Drive Belt Failure Investigation
Time: 8:30 a.m.

A Drive Belt Tensioner assembly from a 1996 Chevrolet Camaro was submitted to the group to conduct a failure analysis. The analysis has been conducted to identify the processing techniques used to produce the assembly, a stress analysis of the assembly has been carried out, and a material analysis of the failed component has been completed. This has allowed the culprit of the failure to be determined and any inconsistencies with the manufacturing of the product to be identified.



(left to right) Chris Mathews, John Pasko, Evan Lemaster

Group Name: No Mow Worries
Project: Mower Deck Mandrel Housing Failure
Time: 9:00 a.m.

The corners on a mowing deck mandrel housing from a riding lawn mower broke off during use. The failure occurred when the blades were engaged and the spindle in the mandrel started rotating. The mandrel was only used for one year and failed before its expected lifetime. Losses include that of the part, and consequently the other components attached to the mandrel suffered damage due to the mandrel failing during use. Testing of the mandrel included scanning electron microscopy of the fracture surfaces, surface replication, dye penetrant, chemical testing, and metallography. Data was analyzed to determine cause of failure and tests will be conducted and compared to that of an exemplar mandrel.



(left to right) Benjamin Humfleet, Keith Leonard, Loren Racicot, Justin Roe

Group Name: Save our Spring (#SOS)
Project: Spring Steel Coil Failure
Time: 9:30 a.m.

Mills operate based on a series of springs and gears, which both provide and support stresses introduced during operation. In the MSU College of Engineering machine shop, a mill suddenly failed, the cause being the sudden break of a spring steel coil attached to the handle. This caused a slowdown in production due to the time and money required to replace the part. This failure investigation has determined the cause of failure, details which led to failure, and steps to avoid any future failures.



(left to right) Eric Shomo, Ethan Gurecki, Martin Scherr

Group Name: Fudd
Project: Failure Analysis of a Winchester
Model 1200 Gun Barrel
Time: 10:00 a.m.

The end of a gun barrel from a Winchester model 1200 shotgun that failed in service has been studied. During the cycle of firing, the end of the barrel experienced catastrophic failure and “tuliped” out in multiple directions. Various petals of the barrel were removed and examined in order to determine the likely failure method. Numerous tests were run on the specimen in order to understand the cause of failure, including dye penetrant testing, X-ray diffraction, chemical testing, hardness tests, and bending tests. The microstructure of the steel was characterized and examined using optical metallography.



(left to right) Matt Keast, Riley O’Shea, Briggs Richmond

Group Name: The Big Three
Project: Half-shaft Low-load Torsional
Fatigue Failure Analysis
Time: 10:30 a.m.

Nexteer Automotive supplied our group with a half-shaft bar that failed during a low-load torsional fatigue validation test at an abnormally low number of cycles (~28,000), compared to the design specifications of 50,000 cycles to pass. A comparative analysis has been done vs. an exemplar, also provided by Nexteer, that failed at about 60,000 cycles. These half-shafts are made of induction hardened 1050 steel. The failed part has been analyzed using scanning electron microscopy, microhardness evaluation, optical metallography, and other techniques to determine the cause of failure.



(left to right) He Zhao, Laura Bartow-Goudie, Jennifer Andrews, Natalia Pajares

Group Name: The Breaker Bar-Barians
Project: Breaker Bar Failure Investigation
Time: 11:00 a.m.

The purpose of the failure investigation was to ascertain the contributing factors to the fracture of a breaker bar submitted for investigation. This part is used for removing tight fasteners, and it failed during service. At that time, the head of the breaker bar that is intended to be inserted into the fastener broke off from the rest of the body of the breaker bar. The methods to establish the details and causes of the failure included interviews, testing of the part by non-destructive, and destructive testing. Based on the analysis of the reasons for the failure of the breaker bar, a recommendation was made for the future design, manufacture, material choice, and use of this type of breaker bar.



(left to right) John Suddard-Bangsund, Thomas Heuser, Emily Taylor

Group Name: The Shock Squad
Project: Failure Analysis of Rear Shock Absorber for Electric Bike
Time: 11:30 a.m.

The central shaft of the rear shock absorber of an electric bike fractured during a routine road test. Our analysis of the failed part included evaluation of mechanical properties, microstructures, compositional variations, macroscopic defects, and fracture surfaces using a variety of microscopy and mechanical testing techniques, including SEM, EDS, 3-point bend, and stereomicroscopy. The goal of this analysis is to improve the safety of the bike and prevent future failures.

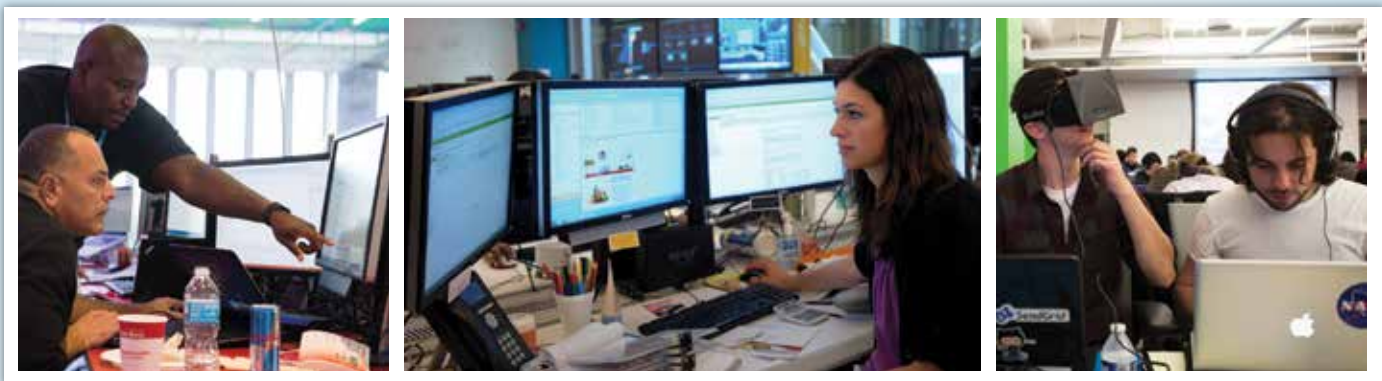

#1 PLACE to Work in IT, Two Years Running

Computerworld has ranked us #1 in the “100 Best Places to Work in IT” for 2013 and 2014!

Now is your chance to join the most creative and innovative IT group around.

Business Consultant/ Project Management Team

- Finds the best new ways to improve current technology and processes while keeping existing projects on track.

Data Operations Team

- Stays laser-focused on making sure all company databases have the highest availability, reliability and security required for our ever-changing business needs.

Business Analyst Team

- Bridges the gap between business and technology by developing new tools.
- Combines business knowledge, math chops and technology know-how to achieve goals for the company on task and on time.

Software Engineering Team

- Includes the genius Programmers, Coders and Developers who are responsible for applications and websites for Quicken Loans.
- Client platforms include QuickenLoans.com, MySQL and My Perfect Home. Internal platforms include LOLA - a web-based platform used for leads, and AMP - the main record systems for clients in process.

Enterprise Architecture Team

- Ties all IT threads together to make the most of our business by bolstering existing and newly constructed technologies.

Infrastructure Operation Team

- Builds, executes and supports key internal operations and includes our hardworking Desktop Support team.

Apply Now

QuickenLoansCareers.com
(800) 411-JOBS



@QLCareers



Quicken Loans



Quicken Loans

Quicken Loans®

Technology Recruiting

Computer Science and Engineering

Capstone Course Sponsors

We thank the following companies for their generous support of the computer science capstone course.

Amazon

Seattle, Washington & Detroit, Michigan



Auto-Owners Insurance

Lansing, Michigan



The Boeing Company

St. Louis, Missouri



Ford Motor Company

Dearborn, Michigan



General Motors

Detroit, Michigan



Meijer

Grand Rapids, Michigan



MSU Federal Credit Union

East Lansing, Michigan



Quicken Loans

Detroit, Michigan



Spectrum Health System

Grand Rapids, Michigan



TechSmith

Okemos, Michigan



Urban Science

Detroit, Michigan



Whirlpool Corporation

Benton Harbor, Michigan





The Capstone Projects

Dr. Wayne Dyksen
Professor of Computer Science and Engineering

Presentation Schedule – Engineering Building, Room 3405

Time	Team	Project Title
7:30 a.m.	Amazon	SIFT: Seller-Forums Information Filtering Tool
7:50 a.m.	Auto-Owners	Claims First Notice of Loss Application
8:10 a.m.	Boeing	Business Developer’s Electronic Sales Bag
8:30 a.m.	Ford	Electric Vehicle Charging Station App
8:50 a.m.	GM	Employee Companion Mobile Application
9:10 a.m.	Meijer	Product Availability Check using Glassware
9:30 a.m.	Break	
9:45 a.m.	MSUFCU	Financial 4.0 Interactive Budgeting Tool
10:05 a.m.	Quicken Loans	Parking Allocation and Expense Reconciliation
10:25 a.m.	Spectrum Health	Mobile Appointment Check-In and Payment
10:45 a.m.	TechSmith	Enterprise Learning Activity Capture
11:05 a.m.	Urban Science	Global Dealer Census and Market Share Viewer
11:25 a.m.	Whirlpool	Launder: Laundry Room Tablet Payment System

CSE 498 Collaborative Design

CSE 498, Collaborative Design, provides the educational capstone experience for all students majoring in computer science. The course objectives include the following:

- Designing, developing, and delivering a comprehensive software system to a client;
- Learning to work effectively in a team environment;
- Developing written and oral communication skills;
- Becoming proficient with software development tools and environments;
- Learning about system building and system administration; and
- Considering issues of professionalism and ethics.

Project sponsors are local, regional, and national, and have included Amazon, Auto-Owners Insurance, Boeing, Bosch, Chrysler, Dow, Electronic Arts, Ford, GE Aviation, General Motors, Google, IBM, Meijer, Microsoft, Motorola Mobility, Mozilla, MSU Federal Credit Union, Quicken Loans, Spectrum Health System, TechSmith, Toro, Union Pacific Railroad, Urban Science and Whirlpool.

The Capstone Experience Lab

Sponsored By



URBAN SCIENCE.

We thank Urban Science for their generous support of the Capstone Experience Lab.



Amazon

SIFT: Seller-Forums Information Filtering Tool

Amazon Marketplace provides a platform for individuals and businesses to sell products to hundreds of millions of online customers. Currently, more than 40% of Amazon sales result from third-party sellers.

In order to improve and optimize the experiences of their third-party sellers, Amazon provides Seller Forums on which sellers can post questions and answers to questions.

Worldwide, Amazon sellers post about 65,000 questions and 2,100,000 answers per year. Without an automated way to analyze these posts, it is very difficult for Amazon to get a sense of trending topics, pain points and areas to be improved.

SIFT, *Seller-Forums Information Filtering Tool*, analyzes the Seller Forums using natural language processing to classify the posts into groups clustered around common themes. These clusters identify currently trending topics within the seller forums, thereby helping the Amazon Seller Services team to resolve potential issues for their sellers.

The clustering of posts into topics can be refined by specifying the number of clusters to be created, a date range and other cluster-specific settings.

SIFT's dashboard displays the current state of trending topics on the Seller Forums. Amazon Seller Services team members can view, search and filter posts related to each cluster.

SIFT is written in Python using the Django web framework. A MySQL database is hosted on Amazon's Relational Database Service, which is hosted on Amazon's Elastic Cloud Computing through Amazon Web Services.



Michigan State University

Team Members (left to right)

Max Goovaerts
Ann Arbor, Michigan

Benjamin Taylor
Champaign, Illinois

Luke Pritchett
Midland, Michigan

Johnny Zheng
Dalian, Liaoning Province, China

Carl Johnson
Rochester Hills, Michigan

Amazon

Project Sponsors

Peter Faricy
Seattle, Washington

Darren Krape
Seattle, Washington

John Marx
Detroit, Michigan

Poornachandra Pesala
Detroit, Michigan

Auto-Owners Insurance

Claims First Notice of Loss Application

Auto-Owners Insurance, a Fortune 500 company founded in 1916, is the 15th largest insurer in the country. Auto-Owners is known for its exceptional financial strength and customer service among the nation's largest insurers.

The experience of a loss of any kind can be a very difficult time. Auto-Owners is committed to providing its policyholders with claim service that is as simple and as stress free as possible during these difficult times.

Using our *Claims First Notice of Loss Application* Auto-Owners' policyholders can submit their initial claim information, called their "first notice of loss," using their mobile phones at any time and from anywhere.

Our application supports both home and automotive claims. Policyholders can attach photos, location data, damage descriptions and audio. Nearby emergency services can be located and contacted. Policyholders can communicate directly with Auto-Owners customer service representatives.

Our software system includes a separate web application that independent Auto-Owners agents use to view claims submitted through the mobile application. Agents set notification preferences specifying how they would like to be notified about claims. The agents can choose between email, text message and automated voicemail notifications.

Our *Claims First Notice of Loss Application* is a cross-platform CSS, HTML and JavaScript mobile application that submits data to a Django web service. The claim data is stored in a MySQL database.



Michigan State University Team Members (left to right)

David Kircos
Grosse Pointe, Michigan

Anthony Tesorero
Wixom, Michigan

Alex Morton
Novi, Michigan

Si Wang
Liuzhou, Guangxi, China

Auto-Owners Project Sponsors

Scott Lake
Lansing, Michigan

Sherry McKenzie
Lansing, Michigan

Jim Schumacher
Lansing, Michigan

Jim Walsh
Lansing, Michigan

Jamie Whisnant
Lansing, Michigan

The Boeing Company Business Developer's Electronic Sales Bag

Boeing is the world's largest aerospace company and leading manufacturer of commercial and military aircraft, spacecraft, defense systems and missiles. This wide array of products and services is marketed at customer meetings, trade shows and other forums by Boeing business developers.

Today pilots no longer carry heavy "flight bags" full of printed maps. Instead, small tablet computers serve as "electronic flight bags" providing pilots with hundreds of maps on a single mobile device.

Similarly, our *Business Developer's Electronic Sales Bag* provides Boeing business developers with access to all of their sales tools using a single tablet computer, replacing "sales bags" full of printed materials with electronic versions.

In addition to providing electronic versions of marketing materials, our electronic sales bag enables Boeing business developers to manage all aspects of the business development process including scheduling meetings, organizing materials for specific customers, and documenting meetings.

Everything within our *Business Developer's Electronic Sales Bag* is available to Boeing business developers regardless of Internet connectivity. Business developers no longer need to worry about forgetting any marketing materials because the entire collection is available at anytime from anywhere.

Our *Business Developer's Electronic Sales Bag* is a native Windows Surface Pro 3 app. It is written in C# and uses an underlying SQLite database.



Michigan State University

Team Members (left to right)

Mike Gerard
Rochester Hills, Michigan

Andy Lieblich
Milford, Michigan

Jourdan West
Detroit, Michigan

Dan Roman
Sterling Heights, Michigan

Boeing

Project Sponsors

Matt Daniels
St. Louis, Missouri

Bob Dyksen
St. Louis, Missouri

Colleen Merz
St. Louis, Missouri

Margo Schoolfield
St. Louis, Missouri

Larry Strube
St. Louis, Missouri

Jayson Vincent
St. Louis, Missouri

Ford Motor Company Electric Vehicle Charging Station App

Ford Motor Company manufactures and sells Ford and Lincoln cars and trucks across six continents with 224,000 employees and 90 plants worldwide.

Ford has begun producing and selling electric vehicles like the Ford Focus Electric. As the popularity of electric vehicles increases, so does the need for charging stations.

To meet the increased demand at their headquarters, Ford provides numerous charging stations throughout their Dearborn campus.

Our *Electric Vehicle Charging Station App* enables Ford employees to locate unoccupied charging stations on their Dearborn campus via a map and set notifications for when a charging station becomes available, all using their iPhone.

In addition to finding charging stations, our app reminds employees to move their car after it has been parked at a station for more than four hours. A leaderboard keeps track of who follows this recommendation and displays it in the app.

Our system uses Bluetooth devices called Estimote Beacons. Employees obtain and register a Beacon, which they place in their car. The charging station senses the presence of their Beacon and marks the station as occupied by that employee, which updates the employee's iPhone app.

Our *Electric Vehicle Charging Station App* is written in Objective-C. The web services backend is written in Java using the Spring framework. An OpenLDAP server handles our user authentication and storage. A Microsoft SQL Server database stores all other relevant data.

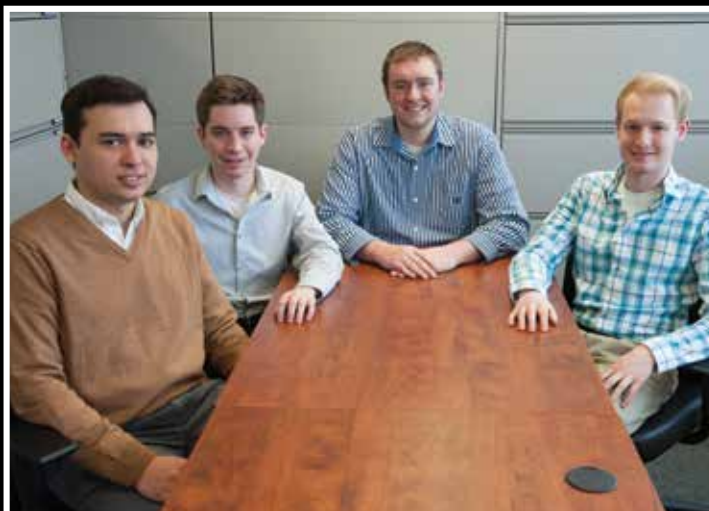
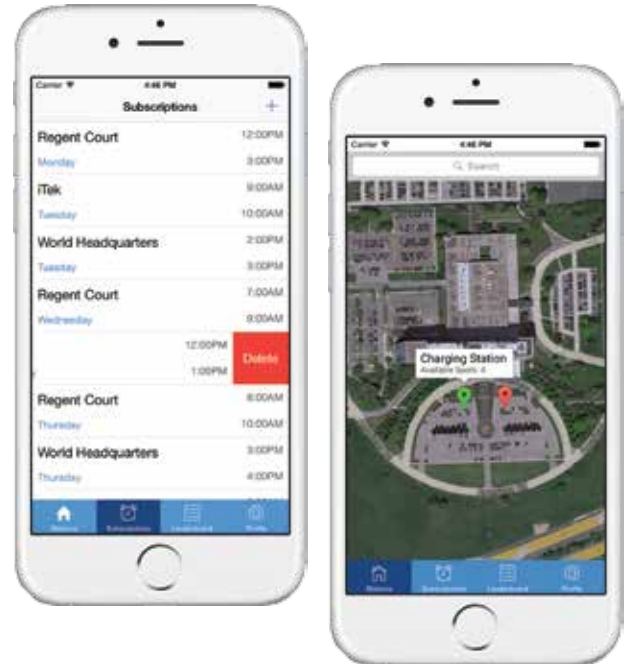

Michigan State University

Team Members (left to right)

Ryan Switzer
Birmingham, Michigan

Kevin Karabon
Dearborn, Michigan

Justin Grothe
South Lyon, Michigan

Brian Jurgess
Kingsley, Michigan

Ford

Project Sponsors

Adam Haas
Dearborn, Michigan

Michael Platt
Dearborn, Michigan

Michael Volk
Dearborn, Michigan

General Motors Employee Companion Mobile Application

With over 100 years of experience in developing and manufacturing innovative vehicles, General Motors is a global leader in the automotive industry.

GM provides convenient Information Technology (IT) Service Centers where employees can go for help with their computers and mobile devices. With over 212,000 employees worldwide, GM supports many IT Service Centers across the globe.

Our *Employee Companion Mobile Application* provides GM employees with quick and easy access to information about IT Service Centers.

After using our app to locate the nearest IT Service Center, GM employees can schedule an appointment by selecting a desired date and time. In addition, they can provide reasons for the appointment along with attached screen-capture images that show examples of their problem.

Once an appointment is scheduled, users can view appointment details including directions to the IT Service Center, building layouts and contact information.

In addition to its scheduling features, our app includes a “Frequently Asked Questions” (FAQ) section where GM employees can post questions as well as view answers to previously posted questions.

Our *Employee Companion Mobile Application* runs on iPhones, iPads and in web browsers. The iOS app is built using Xcode with the Swift programming language. The web app is written using CSS, HTML, JavaScript and PHP. Both use the same MySQL database backend.



Michigan State University

Team Members (left to right)

Nate Seifert
Middleville, Michigan

Jake Ray
Clarkston, Michigan

Yutaka Iwasaki
Rochester Hills, Michigan

Ryan Boyce
Traverse City, Michigan

Derrick Dunville
Orchard Lake, Michigan

GM

Project Sponsors

Mike Adelson
Warren, Michigan

Keith Fry
Warren, Michigan

Joseph Goree
Warren, Michigan

Fred Killeen
Warren, Michigan

Shane McCutchen
Warren, Michigan

Dan Rudman
Warren, Michigan

Christian Stier
Warren, Michigan

Meijer

Product Availability Check using Glassware

Meijer is one of the country's largest supercenters that provides high quality food and merchandise to several states across the Midwestern United States. With their headquarters located in Grand Rapids, Michigan, Meijer has over 200 stores, 60,000 team members, and is continually revolutionizing today's shopping experience by utilizing cutting-edge technology.

Our *Product Availability Check using Glassware* system enables Meijer team members to check the availability of products for Meijer customers. Our application supports searching via barcode scanning or voice input and it provides visual feedback regarding availability, quickly and hands-free.

In addition to the Glassware, our system includes a native Android application that also provides barcode scanning capabilities and the ability to view previously scanned products to reduce duplicate scans. While the Glassware screen is only visible to Meijer team members, customers can view product information using this Android application.

The third component of our product availability system is a web application that displays analytics showing the usage of the Glassware and Android apps. Meijer team members can look up products to see how many times they are searched for, including how many times the scans are successful.

The Glassware and Android applications are written in Java with the open source ZBar scanning library. The web application is written using CSS, HTML and JavaScript. Our backend services are hosted on Microsoft Azure, which includes a SQL server and mobile services features.

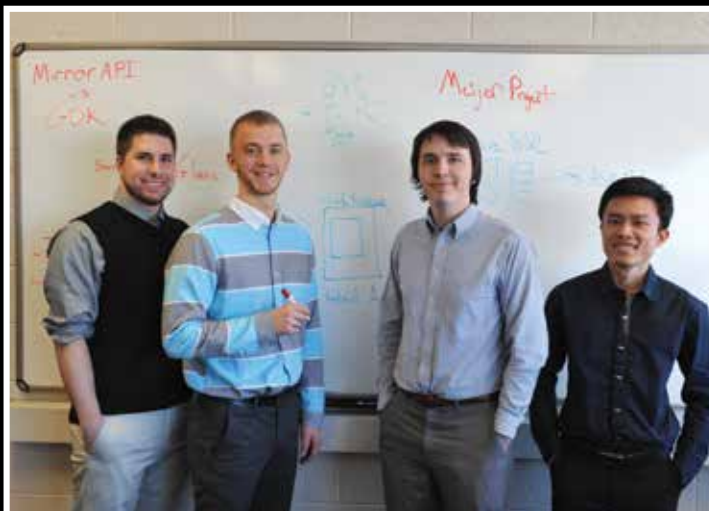

Michigan State University

Team Members (left to right)

Scott Rucinski
Shelby Township, Michigan

Ethan Ettema
Frankenmuth, Michigan

Jim Howell
Belmont, Michigan

Luan Tran
Tuy Hoa City, Phuygen, Vietnam

Meijer

Project Sponsors

Jim Becher
Grand Rapids, Michigan

Chris Laske
Grand Rapids, Michigan

Jim Poll
Grand Rapids, Michigan

Murali Rajagopalan
Grand Rapids, Michigan

Dave Rodgers
Grand Rapids, Michigan

MSU Federal Credit Union Financial 4.0 Interactive Budgeting Tool

Michigan State University Federal Credit Union (MSUFCU) is the largest university-based credit union in the world, serving Michigan State University, Oakland University and their surrounding communities.

As a university-based credit union, MSUFCU is committed to educating students about their finances. To this end, MSUFCU is building a suite of apps called *Financial 4.0* designed to teach students about a variety of important economic topics.

As part of the suite, our *Financial 4.0 Interactive Budgeting Tool* enables students to create and manage personal budgets. In order to make this more appealing and more fun for students, our app includes game-like features.

Students can compete in a variety of financial games such as the “52-Week Money Challenge” and the “Shopping Spree on a Budget.” Winners are awarded points that determine a player’s rank. Future versions of these challenges may include prizes provided by MSUFCU.

In addition to budgeting and gaming, our app provides students with a financial “Tip of the Week.”

This version of *Financial 4.0 Interactive Budgeting Tool* is styled after MSUFCU apps. Our system is designed to be adapted easily to produce a future version styled for Oakland University Credit Union as well.

Our *Financial 4.0 Interactive Budgeting Tool* runs on iPhones, Android devices and within any web browser. It uses HTTP requests to communicate with our server, which in turn are handled using our PHP-based back end.



Michigan State University Team Members (left to right)

Josh Cornett
Clinton Township, Michigan

Vinny Sabatini
Livonia, Michigan

Ashlee DeLine
Adrian, Michigan

Matt LaBrenz
Linwood, Michigan

James Estell
Southfield, Michigan

MSUFCU Project Sponsors

Samantha Amburgey
East Lansing, Michigan

April Clobes
East Lansing, Michigan

Ben Maxim
East Lansing, Michigan

Quicken Loans

Parking Allocation and Expense Reconciliation

Quicken Loans, headquartered in downtown Detroit, Michigan, is the largest online retail mortgage lender in the US. With almost 30 years of experience, their customers include over 2 million American families.

As it rapidly expands its workforce, Quicken Loans faces the continual challenge of meeting the parking needs of its team members, many of whom commute by car.

Quicken Loans is frequently overbilled due to discrepancies between garage managers' invoices and Quicken Loans' records. These discrepancies are reconciled manually by the Quicken Loans Parking Team through a number of processes including spreadsheets and emails to garage managers.

Our *Parking Allocation and Expense Reconciliation* dashboard automates this process by ingesting data from each garage and identifying points of contention. Our system also provides an easy way to communicate problems to garage managers by generating and sending issue reports.

The dashboard manages invoices and visualizes numerical data such as the number of spots billed each month, which are used to track and monitor parking expenses. It also includes the ability to monitor team member parking by communicating with badge scan readers located in several garages and displaying parking activity, thereby enabling the Parking Team to optimize usage and allocate spots as needed.

Our dashboard is written in C# using the .NET Framework. The underlying database is Microsoft SQL Server 2012. The front end uses Google Maps, AngularJS and jQuery.

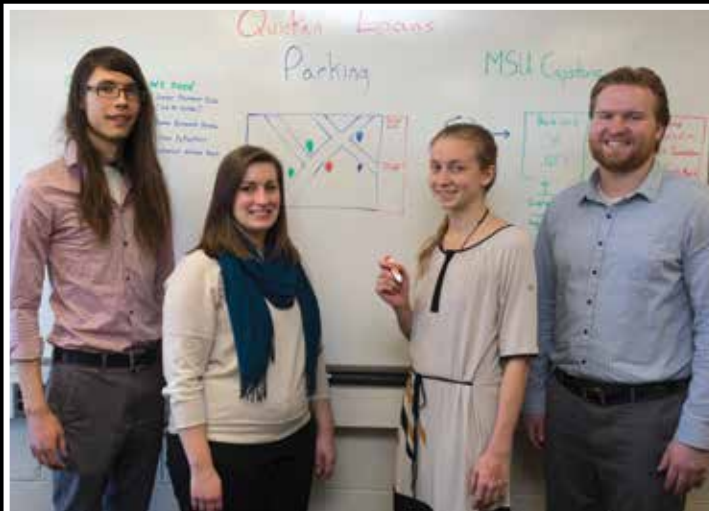
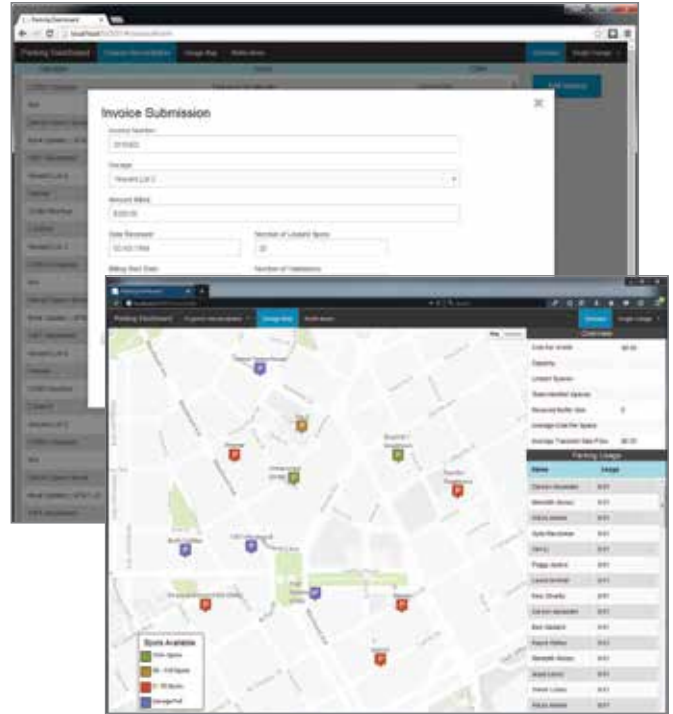

Michigan State University Team Members (left to right)

Tim Hasselbeck
Millington, Michigan

Elizabeth Florian
Charlotte, Michigan

Chelsea Bridson
Lansing, Michigan

Matt Soulliere
Armada, Michigan

Quicken Loans Project Sponsors

Pat Hartford
Detroit, Michigan

Linglong He
Detroit, Michigan

Megan LaFave
Detroit, Michigan

C.J. Mytych
Detroit, Michigan

Brian Percy
Detroit, Michigan

Ted Williamson
Detroit, Michigan

Spectrum Health System

Mobile Appointment Check-In and Payment

Based in Grand Rapids, Michigan, Spectrum Health is a not-for-profit health care system serving more than one million patients every year. Spectrum Health offers a variety of services that involve hospitals, treatment facilities and physician practices.

Spectrum Health is working to become the national leader in health care by the year 2020. One component of their strategy to improve the patient experience is the use of innovative mobile technologies.

Our *Mobile Appointment Check-In and Payment* system revolutionizes the check-in process by allowing patients to check in for appointments and make payments using their personal mobile devices.

Upon arrival at a Spectrum Health facility, our system sends patients a notification informing them that they have an appointment available for mobile check-in. Once signed into the app, patients verify their personal and insurance information making any corrections directly from their mobile device. Patients can also sign any waivers or compliance agreements that may have changed since their last visit.

After the check-in process is complete, patients can process their copayment along with any other balance on their account using PayPal. A floor map of the facility guides patients to their appointment.

Our app is written using Angular JS, HTML and C# using Apache Cordova to produce versions for iPhones, iPads and Android phones and tablets.

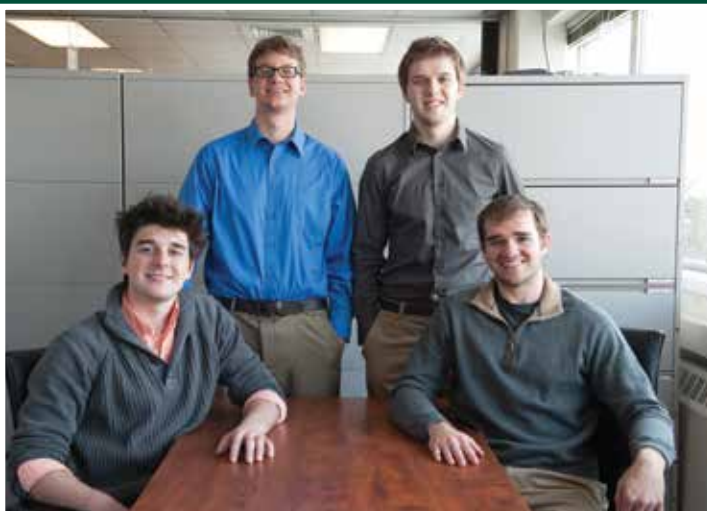
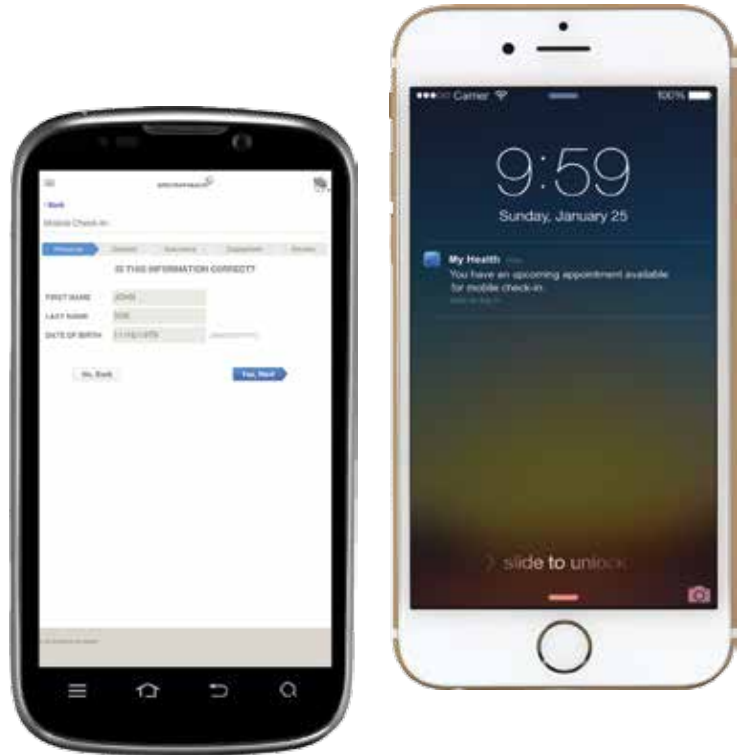

Michigan State University Team Members (left to right)

Joe Reeder
Grand Blanc, Michigan

J. J. Peter
Cincinnati, Ohio

Eric Drews
Elk Rapids, Michigan

Justin Rush
Novi, Michigan

Spectrum Health Project Sponsors

Adam Bakker
Grand Rapids, Michigan

Mary Delrue
Grand Rapids, Michigan

Jane Gietzen
Grand Rapids, Michigan

Matt Hahnfeld
Grand Rapids, Michigan

Markus Neuhoff
Grand Rapids, Michigan

Patrick O'Hare
Grand Rapids, Michigan

Mike Ply
Grand Rapids, Michigan

Mark Welscott
Grand Rapids, Michigan

TechSmith

Enterprise Learning Activity Capture

TechSmith is a leading software developer of screen and video capture and editing software including the very popular Snagit and Camtasia Studio, which are used by companies and educational institutions around the world.

Creating such a wide variety of software requires TechSmith software developers to use an equally wide variety of technologies. When faced with the challenge of learning a new technology, it is helpful to find a colleague who already knows it. Yet finding the right person “in the know” is hard to do.

Our *Enterprise Learning Activity Capture* system captures the learning activities, and hence the skillsets, of TechSmith developers and records these activities in a special database called a Learning Record Store.

Implemented as a Microsoft Office application, our system runs seamlessly within the entire Microsoft Office suite, appearing as a task pane within Office. Users only need to log into our system once, after which it runs unobtrusively in the background.

While looking through Office documents, TechSmith software developers can search for other developers who already know particular technologies and have the skillset of interest. After a user enters a search topic, our system points developers to their colleagues who can help them the most.

Our *Enterprise Learning Activity Capture* system uses the Advanced Distributed Learning’s Learning Record Store, the TinCan API, CSS, HTML5, JavaScript and Bootstrap.

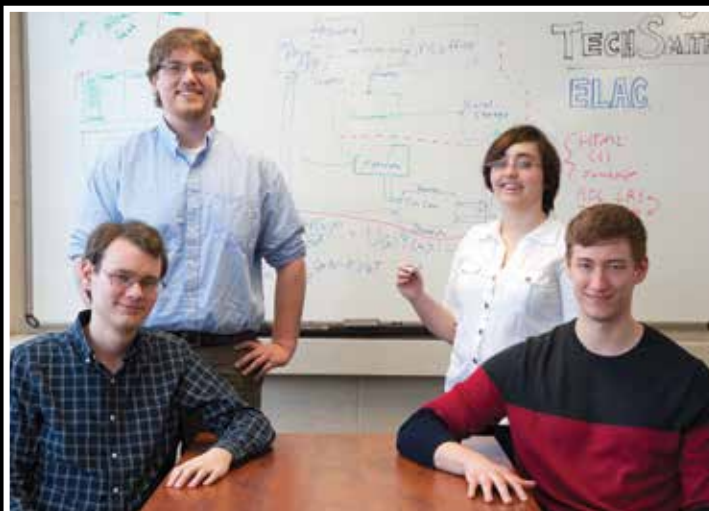
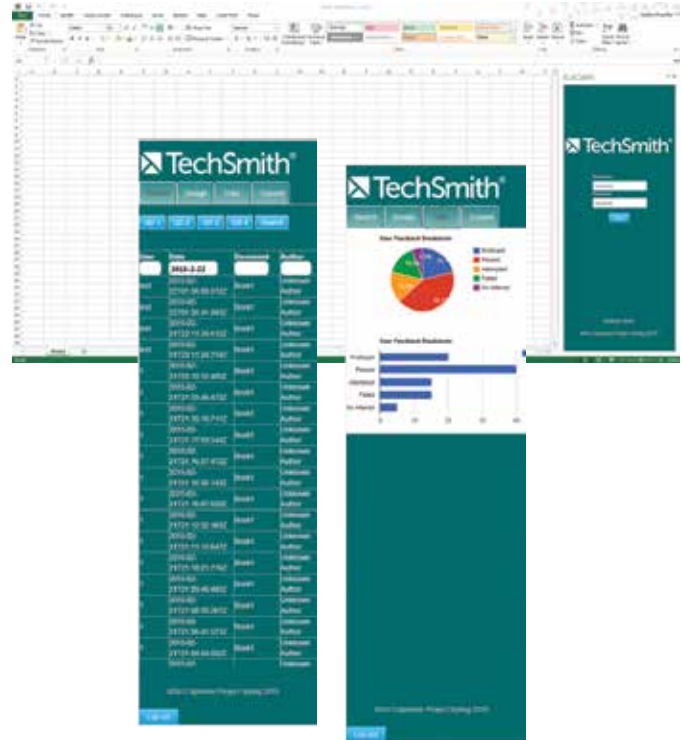

Michigan State University

Team Members (left to right)

Drew Murray
Midland, Michigan

Ben Blazy
Midland, Michigan

Mariah Gilman
Georgetown, Colorado

Stephan Hutecker
Walled Lake, Michigan

TechSmith

Project Sponsors

Matt Ao
Okemos, Michigan

Dean Craven
Okemos, Michigan

Dave McCollom
Okemos, Michigan

Nick Wender
Okemos, Michigan

Urban Science

Global Dealer Census and Market Share Viewer

Urban Science delivers consulting and software solutions that help automotive clients increase market share and boost profitability through high performing retail networks.

At each of Urban Science's automotive partners, the global marketing managers are responsible for understanding what cars are selling where and how these sales relate to their competition.

These automotive marketing managers review market statistics through a variety of metrics, providing their assessments to executives who use them to make strategic investments in new products and dealerships. Currently, this information is obtained using multiple disparate systems.

Our *Global Dealer Census and Market Share Viewer* system is a robust multi-platform application that consolidates and visualizes global market share data in one convenient place.

Using a map interface, managers can drill down to region and country level statistics, and analyze the data using a variety of metrics. Graphs and charts provide helpful visualizations. Managers can receive push notifications when updated market share data become available.

The CEO view shows a high-level summary report of a company's market and franchise share versus its competitors.

Our system includes a web app along with native apps for iPad and Android tablets. The web app is written in JavaScript using ASP.NET MVC with a Microsoft SQL backend database. The iPad application is written using Swift and Objective C. The Android application is written in Java.

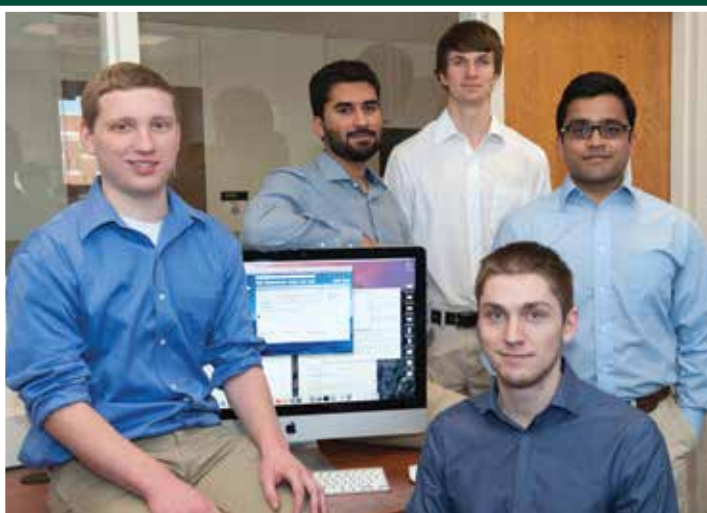

Michigan State University

Team Members (left to right)

Lucas Madill
Midland, Michigan

Abdulla Alkawai
Qatif City,
Eastern Province, Saudi Arabia

David Pusdesris
Romeo, Michigan

David Warner
Beulah, Michigan

Dhruv Rajput
Canton, Michigan

Urban Science

Project Sponsors

Matt Bejin
Detroit, Michigan

Sam Bryfczynski
Detroit, Michigan

Michael DeRiso
Detroit, Michigan

Elizabeth Klee
Detroit, Michigan

Kathy Krauskopf
Detroit, Michigan

Mitch Phillips
Detroit, Michigan

Christian Welch
Detroit, Michigan

Whirlpool Corporation

Laundry: Laundry Room Tablet Payment System

Whirlpool is a global leader in the design and manufacture of appliances including an innovative line of Smart Appliances, which are Wi-Fi enabled and connected to the Internet.

Whirlpool's commercial washers and dryers are widely used in public laundry facilities such as college dorms and apartment complexes. Using their Internet connectivity, these machines can provide lots of useful information, such as the price of a wash or the time when a load in a washer or dryer is done.

Laundry, our *Laundry Room Tablet Payment System*, is a payment and information terminal for Whirlpool washers and dryers. It runs on dedicated tablet computers in unattended public laundry facilities. Laundry is simple and easy to use, even by customers with no experience using mobile apps.

Laundry enhances customers' laundry room experiences in a variety of novel ways. Customers receive text messages when a machine becomes available or when their wash or dry is done, reducing the hassle of waiting in the laundry room.

Customers can send feedback to their laundry room manager, say to report broken machines, and they can gain rewards for consistent use of Whirlpool machines.

Laundry centralizes payment by allowing customers to pay with their credit cards instead of coins, tokens or other payment methods. Laundry optionally emails receipts to users.

Laundry is written in C# and XAML, and runs on Windows 8 and Android tablets.

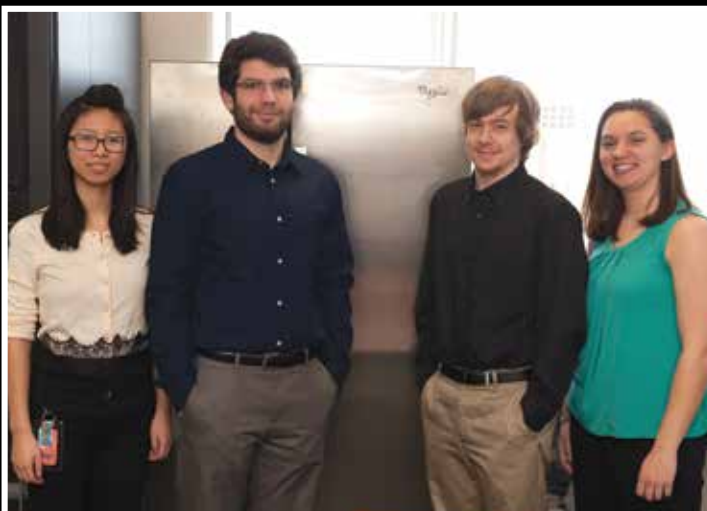

Michigan State University

Team Members (left to right)

Angie Sun
Canton, Michigan

Alex Kambeitz
Macomb, Michigan

Evan Swinehart
Farmington Hills, Michigan

Sam Bentzel
Atlanta, Georgia

Whirlpool

Project Sponsors

Fred Bellio
Benton Harbor, Michigan

Kalpana Prabhu
Benton Harbor, Michigan

Jeffrey Stoller
Benton Harbor, Michigan

Carl Wendtland
Benton Harbor, Michigan

Design Day Awards

CSE 498, Collaborative Design, is the senior capstone course for students majoring in computer science. Teams of students design, develop, and deliver a significant software system for corporate clients. The CSE capstone teams compete for four prestigious awards. The winners are selected on Design Day by a panel of distinguished judges.

Auto-Owners Insurance Exposition Award



CSE 498 capstone teams present their projects on Design Day in a variety of ways. Teams create and set up an exhibit where they demonstrate their software systems and answer questions from Design Day attendees. Each team plays their project videos and answers questions for a panel of judges.

The CSE capstone team with the best overall Design Day performance is honored with the Auto-Owners Exposition Award, which is sponsored by Auto-Owners Insurance Company of Lansing, Michigan.

Team Spectrum Health
Employee Discount Mobile App



Ruchira Ramani, Josh Pelcher, Emily Van Norman, Marco Botros, Aries Xue
Presented by Scott Lake

General Motors Praxis Award



One of the hallmarks of CSE 498 capstone projects is that of praxis, the process of putting theoretical knowledge into practice. Teams apply a wide variety of information technologies to produce solutions to complex problems in areas such as business, engineering, computing, and science.

The CSE capstone team that engineers the software system that is the most technically challenging is recognized with the General Motors Praxis Award, which is sponsored by General Motors of Detroit, Michigan.

Team Auto-Owners
Navigation Assistant and Accident History App



Austin Huynh, Isaac Vogler, Zach Ray, Megan Frankel, Tim Slonec
Presented Christian Stier and Mike Adelson

Design Day Judges

Samantha Amburgey
MSU Federal Credit Union

E. J. Dyksen
Mutually Human

Rich Enbody
Michigan State University

Rob McCurdy
Michigan State University

Marty Strickler
Rose Packing Company

Jayson Vincent
The Boeing Company

Justin Walker
GalaxE.Solutions

Dave Washburn
MSU Foundation

Mark Welscott
Spectrum Health

Karen Wrobel
Chrysler

Joanna Young
Michigan State University

Doug Zongker
Google

TechSmith Screencast Award



Each CSE 498 capstone team produces a video that describes and demonstrates their software product. Starting with a storyboard and a script, teams use Camtasia Studio to synthesize screen recordings, video, audio and other multimedia to produce their project videos.

And the TechSmith Screencast Award goes to... the CSE capstone team with the best project video. The award is sponsored by the creators of Camtasia Studio, TechSmith of Okemos, Michigan.

Team TechSmith
GroupWork for Google Chrome



Gerald Kizer, Spencer Yi, Christian Fincher, Ryan Chen, Justin Fila
Presented by Dean Craven

Urban Science Sigma Award



The CSE 498 experience represents the capstone of the educational career of each computer science major. An intense semester of teamwork produces impressive deliverables that include a formal technical specification, software, documentation, user manuals, a video, a team web site, and Design Day participation. The resulting sum, the capstone experience, is much greater than the parts.

The capstone team that delivers the best overall capstone experience is recognized with the Urban Science Sigma Award, which is sponsored by Urban Science of Detroit, Michigan.

Team Meijer
Mobile Location-Based Product Promotion



Dan Deleclerc, Jason Bull, Kevin Pauly, Xavier Durand-Hollis
Presented by Kathy Krauskopf, Matt Bejin and Mike DeRiso

Auto-Owners Insurance

PROUD SPONSORS OF

THE MSU COLLEGE OF ENGINEERING
DESIGN DAY SPRING 2015

FOUNDED AND BASED IN MID-MICHIGAN.
RANKED FORTUNE 500 SINCE 2002.
EMPLOYER TO SOME OF MSU'S FINEST.

Auto-Owners Insurance



LEAD. LEARN. DO BOTH AT GM.

There's an unmistakable momentum happening at GM. Now, more than ever, we're poised to shape the future of tomorrow, today. From robust IT initiatives to shortened software development cycles, GM is defying convention to elevate the automotive industry as we know it. Bring your ideas and lend your experience to an international company that's as excited about your success as we are our own. Take the next step in your career at GM and discover what our employees already know — that together, there's no stopping us.



WE ARE THE DRIVING FORCE



WWW.CAREERS.GM.COM

GM 2015. The policy of General Motors is to extend opportunities to qualified applicants and employees on an equal basis regardless of an individual's age, race, color, sex, religion, national origin, disability, sexual orientation, gender identity expression or veteran status.

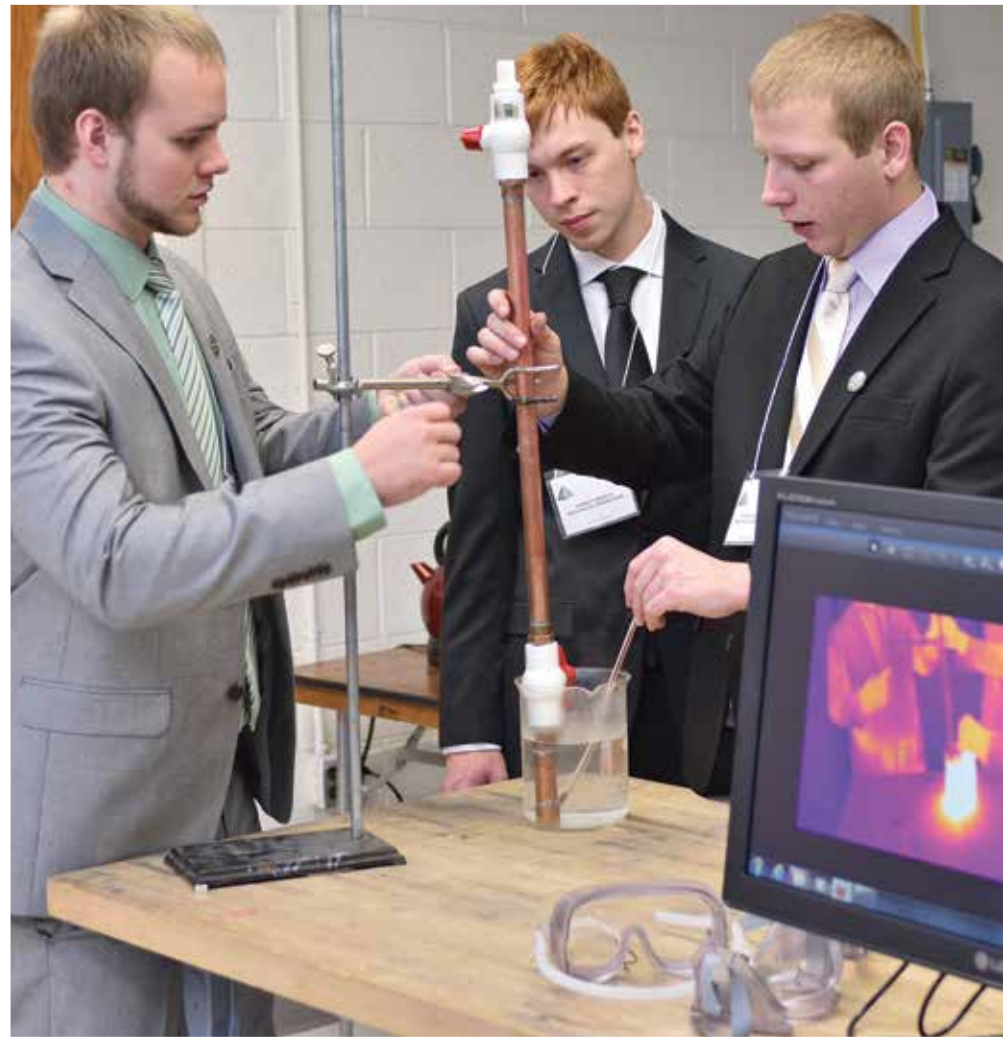



ECE 101 Introduction to Electrical and Computer Engineering

Dr. Dean M. Aslam
Professor of Electrical and
Computer Engineering

Thrills for Pre-collegiates: Mechanisms that Fascinate, Captivate, Stimulate and Entice

ECE 101 is an elective course introducing freshman students to Electrical and Computer Engineering through a series of innovative hands-on laboratory experiments linked to new research and teaching areas. These experiments relate to: (a) computer switches, (b) mind-control robots, (c) program LEGO robot using C-code (MSP430 microcontrollers) and NXT controllers, (d) pH measurement using NXT sensors, (e) maple-seed robotic fliers (MRF) with onboard electronics, (f) location of bio-molecules using RFID, (g) renewable energy resources using windmill and solar cells, and (h) nanotechnology study using a LEGO gear-train.

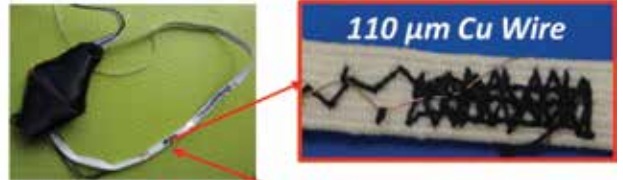

Team Members	Project Title
Guilherme Bredarezende James Weldon	Self-balancing Robot
Robert Kenrick Henry Smith James Steele	RFID Tags with NXT Robot
Sam Braxton Morgan McKerchie Devon McKinney	Mind-control MRF
Nathan Essenmacher Jake Gonzales Jeffery Ware	pH Modulator
JieJia Shan Zac Taylor Ten Xu	NXT Robot and EV3 Robot in Everyday Situations





ECE 410
VLSI Design

Dr. Fathi M. Salem
Professor of Electrical and Computer Engineering

A Programmable (adaptive) Filter in CMOS ICs

Integration of sensors (microphones or cameras) with quick decision on-the-fly leads to many appealing applications in new generation smartphones. Example applications are in speech recognition, natural language processing, language translation, image recognition, identifications, image tagging, navigations, etc. Simply, powerful and adaptive processing would assist the smartphone user with information, voice, image, and data. There are new forms (architectures and designs) of adaptive and/or programmable Finite-Impulse-Response (FIR) filters that, if designed as modules into integrated circuits (ICs), could bring new capabilities onto the smartphone (and off of the cloud). There is also an added security benefit.

Each team of 5 Students in ECE 410 is challenged to design (from schematic to physical layout and verification) a programmable FIR filter (with 16 to 64 taps). The FIR filter architecture will be designed into an IC chip-die guided by the performance metrics. Each team will address the full sensory signal processing path and make decisions regarding processing the sensed physical analog signal in: (i) purely digital mode, (ii) purely analog mode, or (iii) mixed signal mode, in order to best meet an optimized design. A complete CMOS module will be designed, simulated with layout, and verified using the industry standard Cadence VLSI design tools. The teams' project outcomes will be judged on their ability to satisfy several competing performance metrics: (i) execution speed, (ii) power consumption, and (iii) total die (module) area.

Team 1	Team 2	Team 3	Team 4
Trevor Dirheimer	Ian Bacus	Xue Cheng	Goksu Adanali
Jacob Kneibel	Yousef Gtat	Hanqing Wang	Mohamadou Diatta
Spencer Krug	Yujie Hao	Yanqi Wang	Kun Qian
Sean Stewartmoore	Craig Stoddard	Chen Yu	Courtney Smith
Deliang Wang	Richard Szink	Shaochen Zhong	Barend Ungrodt

Team 5	Team 6	Team 7	Team 8
Haiyang Hong	Ruowan Ji	Kelton Ho	Mitchell Johnson
Erik Juziuk	Tianhang Sun	Alex Kohler	Charlie Nguyen
Zhongyang Wang	Emmanuel Wadieh	Matthew Luzenski	Matthew Rasmussen
Jiawei Wu	Qifan Wang	Samuel Metevia	Nathan Vargo
Ning Zheng	Ziye Xing	David Torres-Reyes	Cody Wilson

The Capstone Projects



Dr. Timothy Grotjohn
Professor of
Electrical and Computer
Engineering



Dr. Lalita Udpa
Professor of
Electrical and Computer
Engineering

Presentation Schedule – Rooms 2205 and 2250 Engineering Building, Second Floor

Room 2205	Team Sponsor	Project Title
8:15 a.m.	MSU College of Engineering	Surgical Tool Utilized in Unsanitary Conditions
8:40 a.m.	3D Vision Lab, MSU	Automated 3D Model Building
9:05 a.m.	Asante Solutions, Inc. & MSU Resource Center for Persons with Disabilities	Accessible Insulin Pump
9:30 a.m.	MSU Resource Center for Persons with Disabilities & College of Engineering	Smart Walker Design
9:55 a.m.	Break	
10:10 a.m.	Instrumented Sensor Technology	Lightning Strike Detector, Counter and Time Log
10:35 a.m.	ArcelorMittal	Crane Collision Avoidance
11:00 a.m.	ArcelorMittal	Smart Gate

Room 2250	Team Sponsor	Project Title
8:15 a.m.	ECE Department, MSU	High Resolution Ultrasound for Telemedicine
8:40 a.m.	Great Lakes Controls and Engineering	Screw Machine Tool Condition Monitoring
9:05 a.m.	MSU Technologies	Multi-Material 3D Printer
9:30 a.m.	MSU Solar Car Team	CAN Lighting System
9:55 a.m.	Break	
10:10 a.m.	Whirlpool Corporation	Dispenser Cup Design
10:35 a.m.	MSU Electro-Optics Lab	Tunable LED Light Source
11:00 a.m.	Consumers Energy	Drone Monitoring of Power Lines



To view these presentations live please visit the Design Day website: <http://designday.egr.msu.edu> and click the *Watch Live* tab in left side menu bar.

ECE 480 Senior Design

ECE 480 is required of all electrical engineering or computer engineering majors at MSU. It prepares students for the workplace, or for graduate school, including:

- Putting into practice the technical skills learned in the classroom, on industrially sponsored team projects, under faculty guidance, doing open-ended design, giving them experience in teamwork, project management, product life cycle management, intellectual property, accommodation issues and entrepreneurship;
- Polishing their communication skills – individual and team – on proposals, reports, résumés, evaluations, posters, web pages, and oral presentations; and
- Requiring each student to complete four individual hardware/software laboratory assignments.

Team sponsors are local and national, including, Asante Solutions Inc, ArcelorMittal, Consumers Energy, Great Lakes Controls and Engineering, Instrumented Sensor Technology, MSU 3D Vision Lab, MSU College of Engineering, MSU Electro-optics Lab, Michigan State Solar Car Team, MSU Technologies, Resource Center for Persons with Disabilities, and Whirlpool. Thank you to each of these team sponsors.

MSU College of Engineering Surgical Tool Utilized in Unsanitary Conditions

Surgical Site Infections (SSI) occur at the location where surgery was performed and can be a result of unsanitary surgical settings and practices. These infections can lead to extended hospitalization, treatment, and even death.

In a study conducted by the Centers for Disease Control (CDC) in the United States from 2006-2008, there were over 16,000 surgical site infections which equated to an overall rate of 1.9% of all operative procedures. However, the prevalence of these infections drastically increases when compared with underdeveloped countries. A similar study conducted in India in 2007 showed 21.6% of patients suffered from surgical site infections. This is the result of improper sterilization methods, operating room ventilation, and availability of antimicrobials.

The goal of this project is to create a surgical tool which is capable of suffusing antimicrobials continuously throughout a surgery to help improve the sanitization of the tool and reduce surgical infections experienced by a patient. A pump powered by a battery will utilize micro-channels to deliver the desired fluid to the tool at a calculated flow rate. The tool will be capable of functioning for a minimum of six hours and will be able to run for the duration of the surgery, minimizing the growth of bacteria.

Improving the sanitization of surgical tools utilized in unsanitary operating rooms can reduce surgical site infections experienced by patients which will decrease hospital stays, and ultimately save lives.



Michigan State University

Team Members (left to right)

Adam Stowe
Grand Rapids, Michigan

Kasey Durkin
Carleton, Michigan

Parker Mojsiejenko
Bridgman, Michigan

Stephanie Le
Holt, Michigan

Jose Carmona
Sturgis, Michigan

MSU College of Engineering

Project Sponsor

Satish Udpa
East Lansing, Michigan

Dr. Daniel Morris, 3D Vision Lab

Automated 3D Model Building

With the widening availability of RGB-Depth cameras to industry and to consumers, new applications for these sensors are in high demand. World modeling is one such application and, while done before in various research projects, the process of using RGB-Depth cameras to model a space has yet to become an automated process. Automating this process would allow for numerous practical applications ranging from military use to helping those with physical disabilities.

The goal of this project is to combine a robotic moving platform and a commercially available RGB-Depth camera to autonomously build a 3D model of a room. The combined device will require additional structural supports and power. A successful device will be able to localize its position when capturing images and integrate images together to build a 3D model. The robot should be able to completely map a room without getting stuck or running out of power and should do so in a timely manner.

Several challenges had to be addressed while working on this project including integrating the various pieces of hardware together, solving the mapping and localization problem, and combining the data from the RGB-Depth sensor into a cohesive and complete 3D model in real-time.

Pictured on right: an example of a 3D model of a room, along with both the RGB-Depth sensor (Microsoft Kinect V2) and robotic platform (iRobot Create 2) used in the project.

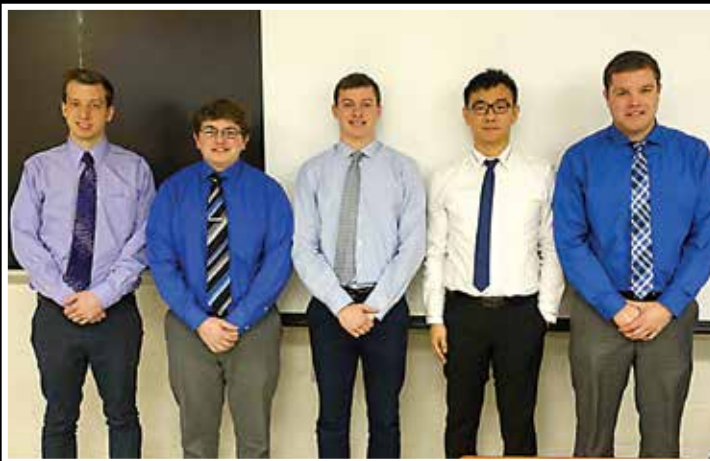

Michigan State University

Team Members (left to right)

Jacob Kneibel
Grand Rapids, Michigan

Nick Zuzow
Redford, Michigan

David Zoltowski
West Lafayette, Indiana

Kexiang Qian
Beijing, China

Nick Saxton
Flint, Michigan

Department of ECE

Project Sponsor

Daniel Morris
East Lansing, Michigan

Asante Solutions, Inc. & MSU RCPD Accessible Insulin Pump

Diabetes is a group of common metabolic diseases in which there are high blood sugar levels over a prolonged period of time. In the United States, there are approximately 29.1 million people who have diabetes. Out of that population, 5.3 million diabetics have a form of retinopathy, which may lead to loss of vision. Diabetics use an insulin pump to balance their blood sugar levels. However, the visually impaired face hardships obtaining the information provided on the current market's pumps. With the assistance of Asante Solutions, Inc. and Michigan State University's Resource Center for Persons with Disabilities, the team is striving to produce an intuitive and functional pump for all users.

An insulin pump administers insulin to the user's body multiple times throughout each day. Vital concerns are during meals as diabetics must be aware of their insulin levels. However, blind users cannot fulfill this action if the insulin pump is not accessible. Many users require assistance and some have trained to do so through memory. The solution to the next generation of insulin pumps is evident in audibility.

To resolve this issue, the team designed an audible insulin pump that retains the simplicity and functionality of a standard insulin pump. Using a microcontroller and text-to-speech chips, the team developed a program that is capable of outputting information on the pump screen audibly. This pump design will present a foundation for the future of insulin pumps in intuitiveness, functionality, and accessibility for all users.

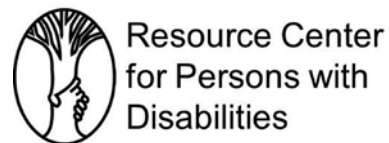
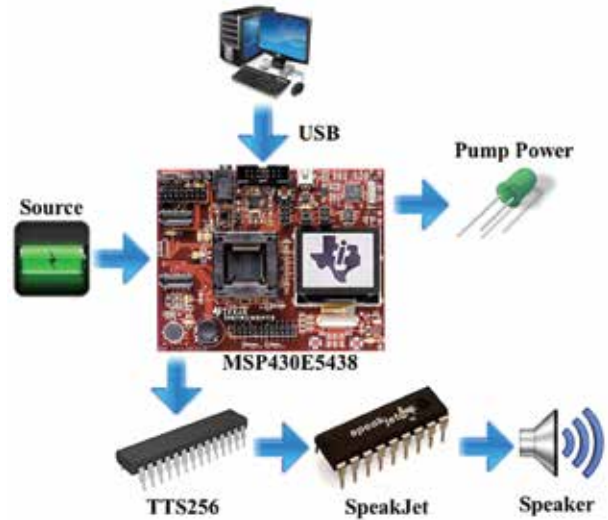

Michigan State University

Team Members (left to right)

Anthony Iafate
Romeo, Michigan

Marshall Williams
Corunna, Michigan

Miri Garcia
Dominican Republic

Hoyoung Jung
Grand Rapids, Michigan

Asante Solutions

MSU RCPD

Project Sponsors

Mark Estes
Sunnyvale, California

Jin Jiang
Sunnyvale, California

Stephen Blosser
East Lansing, Michigan

MSU RCPD & College of Engineering Smart Walker Design

The Resource Center for Persons with Disabilities at MSU provides help and resources for students with disabilities. One day David, a MSU student with a visual and motoric disability was using his walker in an unknown area of campus. As a result, he did not see the flight of stairs in front of him and proceeded to fall down them. Luckily, the injuries he sustained were not major; however it got David and RCPD thinking about the possibilities of a device that could be attached to his walker and alert him of dangerous drop-offs so he would have time to stop.

Upon David's request for a Smart Walker Device, Stephen Blosser and our team have developed a device that will attach to David's walker. The device will warn him of upcoming drop-offs by triggering an auditory alert system so he has enough time to stop.

The Smart Walker Device will be able to extend to others in need of drop-off alert assistance due to its capability to attach to any walker. Also, once a user obtains a new walker, they will have the ability to attach it to their new walker.

A microcontroller will communicate with sensors that will be mounted on the walker to obtain the distance and set a ground reference. Once that ground reference changes from a drop-off being read, the microcontroller will trigger the auditory alert system and warn David to stop.



Michigan State University
Team Members (left to right)

Sean Moore
St. Joseph, Michigan

Yakov Kochubievsky
Ann Arbor, Michigan

Jeffrey Hancock
Grand Blanc, Michigan

Dominic Hill
Battle Creek, Michigan

Trevor Dirheimer
Grand Haven, Michigan

MSU RCPD
College of Engineering
Marathon Oil
Project Sponsors

David Shachar-Hill
(Pictured in front)
East Lansing, Michigan

Stephen Blosser
East Lansing, Michigan

Susan Langendonk
East Lansing, Michigan

Instrumented Sensor Technology

Lightning Strike Detector, Counter and Time Log

Instrumented Sensor Technology (IST) has worked over the past 25 years developing portable dynamic measurement instrumentation for shock, vibration, etc. Their current line of instruments offers everything from low-cost shock detectors to full featured shock and vibration waveform recorders.

Until now IST has only dealt with shock and vibration due to a physical force instead of an electrical pulse, such as lightning strikes.

Direct lightning strikes to buildings may cause disruption to any electrical systems within the building. This can cause errors or data loss to computers that are running at the time of the strike.

Due to this issue, it is beneficial to know if and when a building is struck by lightning. This is why IST is pursuing the development of a lightning strike detector.

Currently, most lightning strike detectors on the market can detect lighting within a few miles. IST is looking to develop a device that will detect a lightning strike within a few feet. This information will help determine if a building is directly hit.

A solution to this issue is to detect a magnetic field that is induced from the lightning surge as it flows through the grounding rod of a building. When a magnetic field is detected, the device will display the time of the strike. This display will provide a maintenance technician with a time log of direct strikes, which will allow the technician to check all electrical systems.



Michigan State University

Team Members (left to right)

Justin Bauer
Canton, Michigan

Zongheng Pu
Chongqing, China

Deandre Dawson
Detroit, Michigan

Matt Clary
Royal Oak, Michigan

Adam McHale
Grosse Pointe Woods, Michigan

IST

Project Sponsor

Greg Hoshal
Okemos, Michigan

ArcelorMittal

Crane Collision Avoidance

ArcelorMittal has been the world's leading steel and mining company for many years. Present in over 60 countries, ArcelorMittal has established a sustainable foundation, working proficiently and focusing on the safety of their members. Priding themselves on the significantly low rate of injuries that take place inside of the facilities, ArcelorMittal has implemented their "Journey to Zero" campaign to completely alleviate any workplace incident in the future.

In order to accomplish their "Journey to Zero," the installation of a crane collision alert system warning an operator of any hazards, is an immediate need at the East Chicago, IN facility. Our team was given the task of designing a collision alert system that will provide an audible and/or visual alarm to the operator as the Electric Overhead Cranes (EOT) approaches a hazard at the same elevation as the crane.

Our collision avoidance system is comprised of two mechanisms: sensing technology and alert system. Using a proximity sensor, it will detect the distance between itself and another crane. Once the cranes come within a close proximity of one another, an alarm will trigger and this process will continue with a more intensified alarm every 50ft to alert the crane operator from colliding with another crane.



Michigan State University

Team Members (left to right)

Marcel Cochran
Chicago, Illinois

Joshua Johnson
Manistee, Michigan

Hang Zhao
Jilin, China

Wenbo Gong
Dalian, China

Le He
Hangzhou, China

Keyon Clinton
Detroit, Michigan

ArcelorMittal

Project Sponsors

James Lang
East Chicago, Indiana

Ning Xi
Facilitator

ArcelorMittal Smart Gate

ArcelorMittal is in need of an efficient and robust entrance that will aid in security, safety and traffic flow. The proposed solution is to use a Matrix RFID Reader, Arduino Yun microcontroller, servo motor, and a video camera to track and secure the gate entrance. A dedicated database table will store the employees' valid identification numbers as well as their time of entry.

Upon entry, personnel will be required to scan either their identification badge, or a QR code which will be placed in a database of people currently in the facility. Upon confirmation, the camera will take a picture in order to verify the integrity of the employee. Upon exit, they will scan out of the gate and be removed from the currently-on-site table. In case of any emergency, a safety engineer will be able to query the database and receive a report of everyone that is currently on the plant grounds.

With the excessive number of trucks that ArcelorMittal receives on a daily basis, roughly 160 semi-trucks per day, and 350 employees, the gate needs to always be running smoothly.

The current "gatehouse" lacks the new technology and efficiency that is readily available in society to not only save time but track who enters and exits the plant grounds.

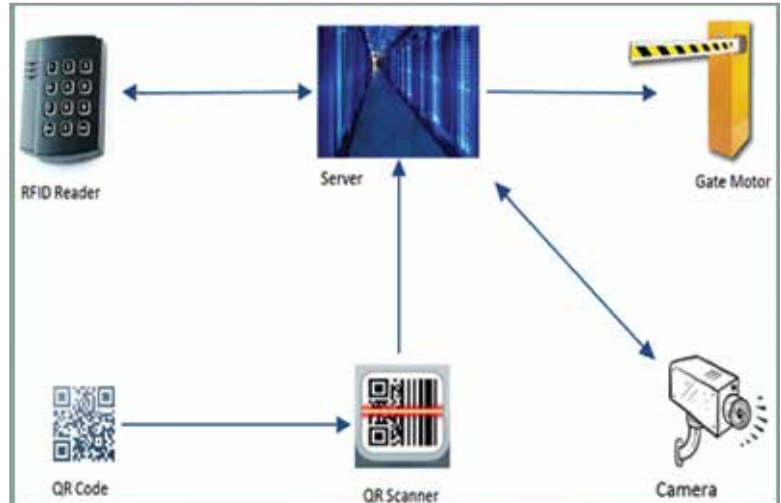

ArcelorMittal



Michigan State University

Team Members (left to right)

Lauren Poole
Seattle, Washington

Trevor Emerick
Troy, Michigan

Jazmine Gaymon
Detroit, Michigan

Bingyang Wu
Suzhou, China

ArcelorMittal

Project Sponsor

Cliff Barnett
East Chicago, Indiana

MSU Electrical and Computer Engineering

High Resolution Ultrasound for Telemedicine

Currently, painful joint or musculoskeletal episodes are often misdiagnosed and treated empirically with clotting factor administration or for arthritis. Often the musculoskeletal pain is caused by hemophilia which causes internal bleeding in the joints. Timely and accurate diagnosis, along with appropriate management procedure, is critical to ensure best recovery for patients with hemophilia.

Rapid Point of Care High Resolution Ultrasound scans are highly desirable in order to diagnose musculoskeletal pain due to hemophilia or due to other joint pathology. Telemedicine and mobile collaborations technology will allow healthcare professionals to timely and accurately diagnose musculoskeletal episodes and prescribe proper management procedures. This potentially can reduce the overall cost of medical care, as well as serve as a path for remote prescription verification and proper drug administration without the need of an outpatient visit.

Our team is developing a system that will wirelessly transmit data from a portable ultrasound device through Wi-Fi to a base station in order to be examined by a physician or a specialist. The system accesses collected data from the ultrasound device after a patient has been scanned using the ultrasound probe. Next, it digitizes and filters the data through a microcontroller and transmits the data using an antenna. On the base station another microcontroller with a built-in antenna receives the signal and displays it on a laptop using commercial software.

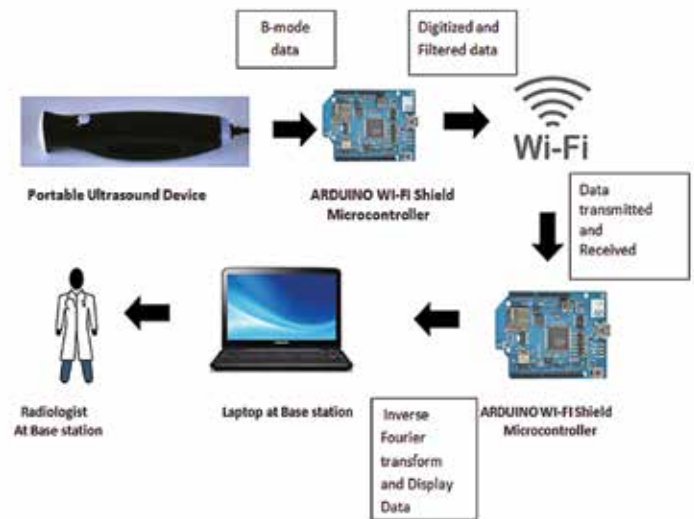

Michigan State University

Team Members (left to right)

Lingyue Fu
Yangzhou, China

Shamanta Hoque Shammi
Dhaka, Bangladesh

Zac Mitchell
Rochester Hills, Michigan

Abdullah Alzahmi
Dubai, United Arab Emirates

MSU Department of ECE

Project Sponsors

Lalita Udpa
East Lansing, Michigan

Rama Krishna Mukkamala
East Lansing, Michigan
Facilitator

Great Lakes Controls and Engineering

Screw Machine Tool Condition Monitoring

Great Lakes Controls and Engineering has identified the problem of monitoring the wear of cutting tools on a six-spindle automatic lathe.

Faulty parts are produced when cutting tools begin to dull or spindle bearings wear beyond nominal limits. Team 10 has been tasked with creating a system to monitor tool life and identify dull tools before they begin producing faulty parts.

The system our team has designed is comprised primarily of an industrial accelerometer, an adjustable band pass filter IC, and a microcontroller. As the tool arm moves in toward the part, the mechanical resistance causes vibrations in the tool arm that can be measured in terms of acceleration. Fluctuations in acceleration are output as differences in voltage over time. The output is analyzed using the band pass filter IC and microcontroller. The system produces an output signal to the lathe's Programmable Logic Controller (PLC).

Pictured on the right is a side view of the New Britain screw machine that the device works on. Horizontally, aluminum rods are fed through each spindle to be machined. The bulky parts on the left side of the picture are the feeders, or tool arms, which hold the tools and slide in and out during production. This is where our accelerometer will be placed.



Michigan State University

Team Members (left to right)

Richard Skrbina
Livonia, Michigan

Kyle Burgess
Okemos, Michigan

Caitlin Slicker
West Bloomfield, Michigan

Chris Vogler
Rochester Hills, Michigan

Ali ElSeddik
Benghazi, Libya

Great Lakes Controls and Engineering

Project Sponsor

Justin Wulz
Stockbridge, Michigan

MSU Technologies Multi-Material 3D Printer

MSU Technologies is exploring a new way to 3D print metal material. It is a plasma-based process that doesn't require as much heat as other metal printing methods. It involves printing the metal in very small thin layers. The result is a method that may be useful in 3D printing multi-material objects.

While the plasma-based metal printing process is not fully developed, a 3D printer capable of printing two materials at once is needed to eventually test the finished product. This team is modifying a dual-headed 3D printer and corresponding software to create an easy way to test the new printing process.

In order to make the testing process simple, a new carriage to hold the material printers will be made. This will allow one of the current plastic printers to be replaced with a metal printer.

There will also be additions to the 3D printing software. The user will be able to specify what materials they are printing. The program will be able to load some defaults based on the material. Further adjustments can be made to the defaults to get the perfect multi-material model. For example, the user may want to specify different temperatures for the different materials, or specify how thick a layer each material will create. This will help the program lay down the correct amount of material per layer. The thinness of the metal layer process means that more layers of metal must be printed for every one layer of plastic.



**MICHIGAN STATE UNIVERSITY
INNOVATION CENTER**
Business CONNECT | MSU Technologies | Spartan Innovations



Michigan State University Team Members (left to right)

Annalin Davis
Kalamazoo, Michigan

Joshua Folks
Canton, Michigan

Michael Saybolt
Bloomfield Hills, Michigan

Matthew Luzenski
Milford, Michigan

He Chen
Worthington, Minnesota

MSU Technologies Project Sponsor

Timothy Grotjohn
East Lansing, Michigan

MSU Solar Car Team CAN Lighting System

The goal of this project is to replace the MSU Solar Car Team's existing central microcontroller CAN system with a simple CAN node system, while maintaining control of all of the 11 signaling lights. The amount of wiring used in this system is to be minimized and purely essential, in order to reduce unnecessary weight in the vehicle. The previous system was easy to implement, but had excessive amounts of wires connecting each signaling light to the central microcontroller. The new system will have a Microcontroller Unit (MCU) to each signaling light, and each MCU will be connected together in a daisy-chain format in order to use the minimal possible length of wire.

The figure to the right shows the final node design. The controller will take in four signals: CAN HI, CAN LOW, the power supply VDD, and the ground connection GND. The BUS will deliver a CAN signal along with the CAN HI and CAN LOW signals. These signals will be interpreted by the CAN transceiver and will be sent to the CAN controller. This interpreted signal will then be sent to the microcontroller. The microcontroller will determine whether or not to execute the command based on its individual programming. If the command is executed, then it will output a signal to the LED driver that will power the LEDs.

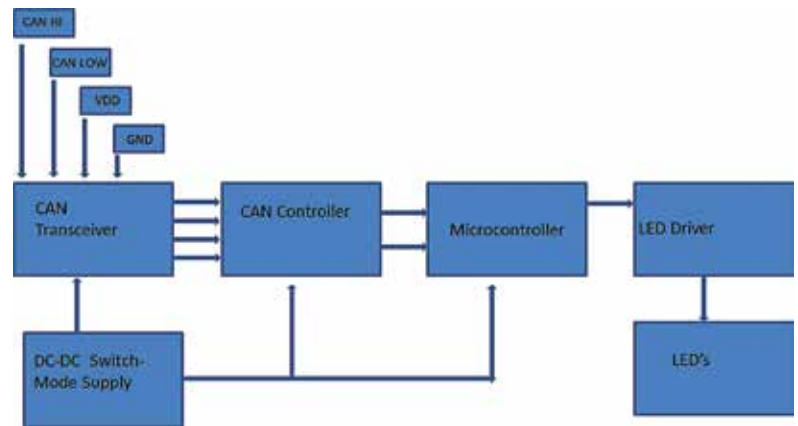

Michigan State University

Team Members (left to right)

Stephanie Stolsky
East Lansing, Michigan

Maxx Coral
Canton, Michigan

Chuck Cashen
Shelby Twp, Michigan

Eleazar Gutierrez
East Lansing, Michigan

Kyle Grager
Sterling Heights, Michigan

The Solar Car Team

Project Sponsor

East Lansing, Michigan

Whirlpool Corporation Dispenser Cup Design

The aim of this project is to prototype a completely functional, yet independent dispenser cup. The independence of this system means that no contact pads or harnesses can be used in between the appliance and the dispenser cup. Our design will not be streamlined into the market but rather it's a proof of concept that the requirements set by Whirlpool are feasible and can be used in future works relating to our project.

By combining an LED and a photo resistor sensor, we can detect when a liquid is placed in one of the cups on the dispenser. A solar cell panel on the outside face of the dispenser will always be exposed to the environment and convert light in the surrounding area into energy used to charge a battery which, in turn, powers the system. The last feature of the system is user-friendly LEDs to indicate which cups need to be filled depending on what cycle the user selects.

The dispenser cup we designed has three layers with different functions. The first and second layers are designed to save more water and detergent that the customers use. In order to do that, we introduced a tilted bottom with a path in the middle of each cup for detergent/bleach/softener to go into the washer. LEDs will be added to indicate the purpose for each cup, and a solar cell will be used to power up the system.

There are three different choices of microcontroller that can be used for the initial and testing: EZ430-RF2500, MSP430-G2553 and CC2500. A 9V solar cell panel, Red LEDs and photo resistors will be used in this project.

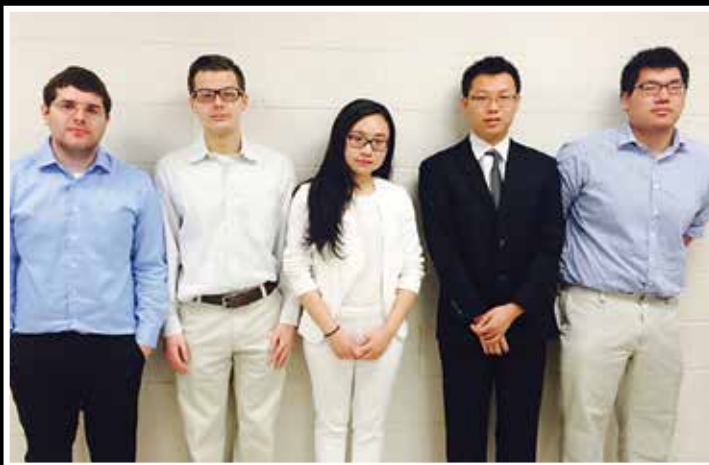
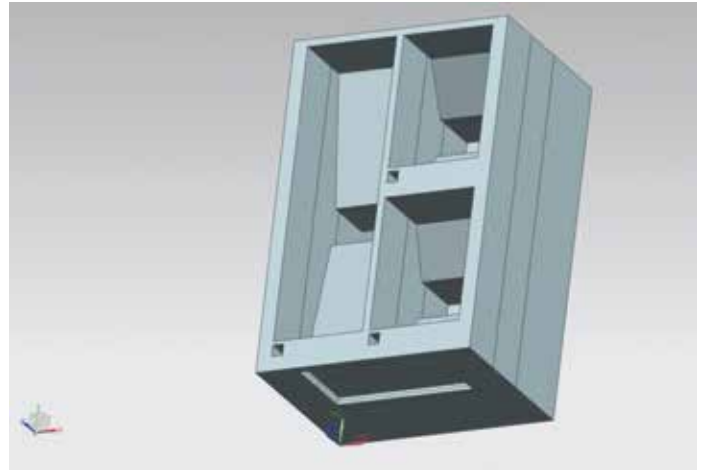

Michigan State University

Team Members (left to right)

Daniel Gomez
Maracaibo, Venezuela

Connor Grossman
Clinton Twp., Michigan

Gao Xin
Yichun, China

Hongyi Shen
Shanghai, China

Daniel Sun
Taipei, Taiwan

Whirlpool Corporation

Project Sponsors

Jeff Landrey
Benton Harbor, Michigan

Basak Oguz
Benton Harbor, Michigan

Jason Savage
Benton Harbor, Michigan

MSU Electro-Optics Laboratory

Tunable LED Light Source

Solar cells play an important role in transforming solar energy into electricity through the photovoltaic effect. As such, they have become a crucial element in providing clean renewable energy as more consumers turn away from traditional fossil fuels. The current method of testing solar cells uses a broadband light source and optical grating to change the wavelength of the light to measure the quantum efficiency of solar cells at local spots. The required components for the current method are housed in a system that is costly, cumbersome, and tabletop in size.

We have created a cheaper, more user-friendly testing device composed of LEDs that can be controlled via a computer to provide at least twenty-five peak wavelength points over a spectral range of 400 nm to 1100 nm. During test operation, the device will illuminate a local spot on a solar cell of area 1 mm² area with a total power of 100 mW while the solar cell is monitored using a voltmeter to determine light-conversion efficiency. The device was requested for use in the Michigan State University Electro-Optics Laboratory to introduce students to the use of solar cells as alternative energy sources.

In addition, we explored additional options for our developed technology. There are potentials for commercial applications of the device as a cheaper portable alternative to current devices on the market. There is also potential in the tunable technology in greenhouse lighting and jaundice treatments.

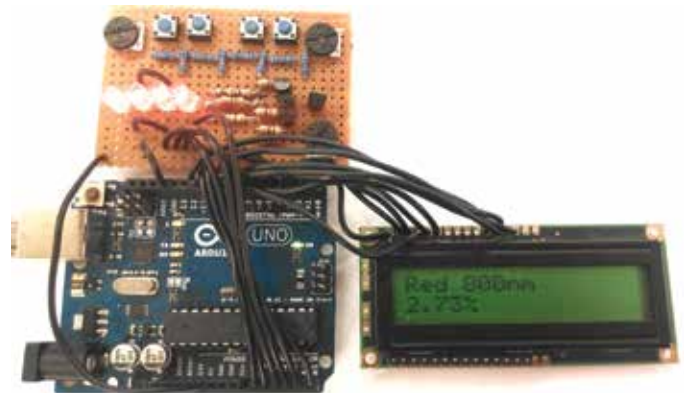
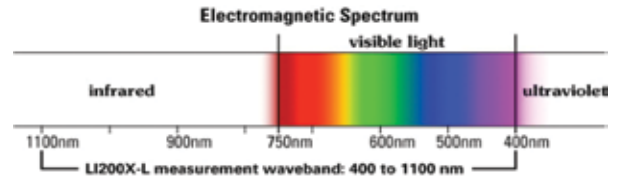

MICHIGAN STATE
UNIVERSITY



Michigan State University

Team Members (left to right)

Isaac Davila
Sparta, Michigan

Ruben Valencia
Ventura, California

John Foxworth
Birmingham, Michigan

Cynthia Patrick
Brighton, Michigan

Haosheng Liu
Zhengzhou, Henan China

MSU Electro-Optics Lab

Project Sponsor

Prem Chahal
East Lansing, Michigan

Consumers Energy

Drone Monitoring of Power Lines

Consumers Energy is one of the nation's largest combination utilities, providing electric and natural gas service to nearly 6.6 million of Michigan's 10 million residents. Preserving service for its customers requires frequent power line maintenance – especially after storms. Consumers Energy desires a more efficient solution for inspection of its power lines. This project has accomplished that objective by using a drone to perform remote power line inspections.

Thermal image inspection of power lines is an industry-wide method for detecting present or potential faults in power lines and other electrical equipment. Utility companies currently perform their inspections by using either handheld thermal cameras or using thermal cameras mounted to helicopters. These methods are both problematic as helicopter operation is expensive, and using handheld thermal cameras in remote areas is both dangerous and difficult.

To address this issue, the team's goal is to create a drone-mountable system that is capable of detecting defective power lines. Detection is performed using a thermal camera and microprocessor mounted on the drone. After a problem is detected, the system records a thermal image, a still image, a short video clip, and a GPS location of the problem area. All problem areas are subsequently plotted on Google Maps for human review, and each plot point will contain the recorded images from the video camera and thermal camera.



Consumers Energy

Count on Us

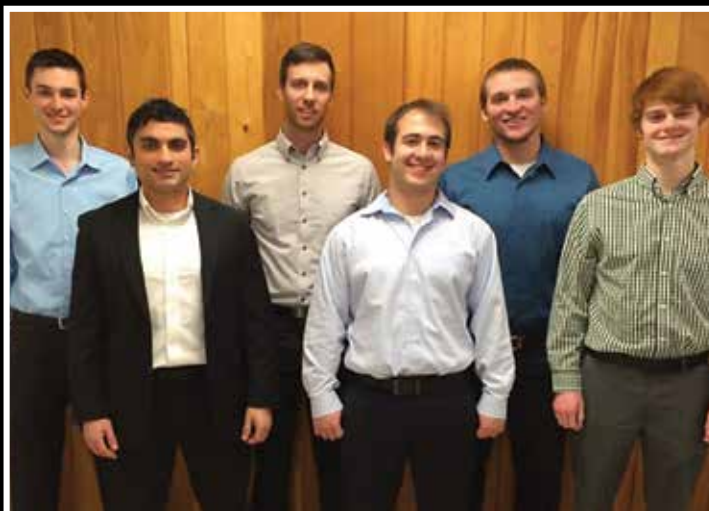

Michigan State University

Team Members (left to right)

Cody Wilson
Farmington, Michigan

Faisal Tameesh
Troy, Michigan

Dan Pittsley
Mt. Pleasant, Michigan

Mitch Johnson
Dimondale, Michigan

Jake Hersha
Jackson, Michigan

Ian Meredith
Brighton, Michigan

Consumers Energy

Project Sponsors

Andrew Bordine
Jackson, Michigan

Amanda Monette
Jackson, Michigan

Design Day Awards Fall 2014

Electrical & Computer Engineering Prism VentureWorks Prize & Winners, Fall 2014

The Prism VentureWorks Prizes (\$1,500, \$1,000, and \$500, respectively) are awarded each semester to the most outstanding teams in the Electrical and Computer Engineering Senior Capstone Design Course, as judged by a panel of engineers from industry. A team with members from both ECE and another engineering major (mechanical engineering, for example) is also eligible, if the team's project is administered through ECE 480. The prizes are sponsored by Prism VentureWorks, a Boston-based venture capital firm, and Mr. William Seifert, an ECE alumnus, who is a partner in that firm. The faculty and students of Electrical and Computer Engineering are very grateful for this generous support.

Prism VentureWorks First Place: Whirlpool Corporation: Dispenser Cup Contents Detection

left to right:

Raymond Acker, Jacob Stanczuk, Doddy Jonathan, Nolan Holmes, Sung Gun Lee, and Trevor Eckler

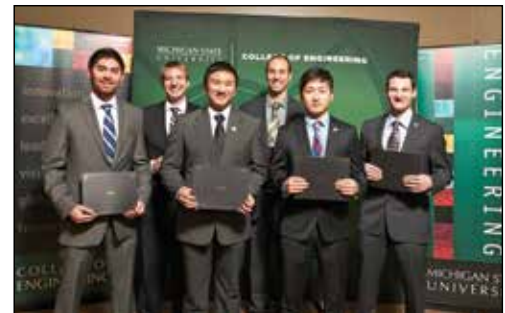

Prism VentureWorks Second Place: MSU College of Engineering: A Point of Sale Grocery Cart

left to right:

Husain Aleid, Ben Lauzon, Shuangfei Liu, Steven Hartz, Taoping Zhao, and Matt Rasmussen



Prism VentureWorks Third Place: MSU Electrical and Computer Engineering: Compact DC/AC Power Inverter

left to right:

Jack Grundemann, Jacob Brettrager, Travis Meade, Phillip Beard, and Stanley Karas



LET'S WORK TOGETHER TO **GROW IDEAS**

INTO BUSINESS **SUCCESS STORIES.**

You might be surprised at what you find at the MSU Innovation Center: access to nearly 5,000 researchers, \$526 million in annual R&D expenditures and 644 research and instructional buildings, scale-up facilities, pilot plants and lab spaces.

We have the world class ingredients that entrepreneurs, investors, and inventors are looking for, all in one place. You will also find experienced partners committed to your success:

- **Business-CONNECT** links the right people and resources to develop your idea
- **MSU Technologies** offers the best MSU ideas for commercial licensing
- **Spartan Innovations** turns MSU ideas into investment-ready businesses

**MSU INNOVATION CENTER
WANTS TO SUCCEED WITH YOU**

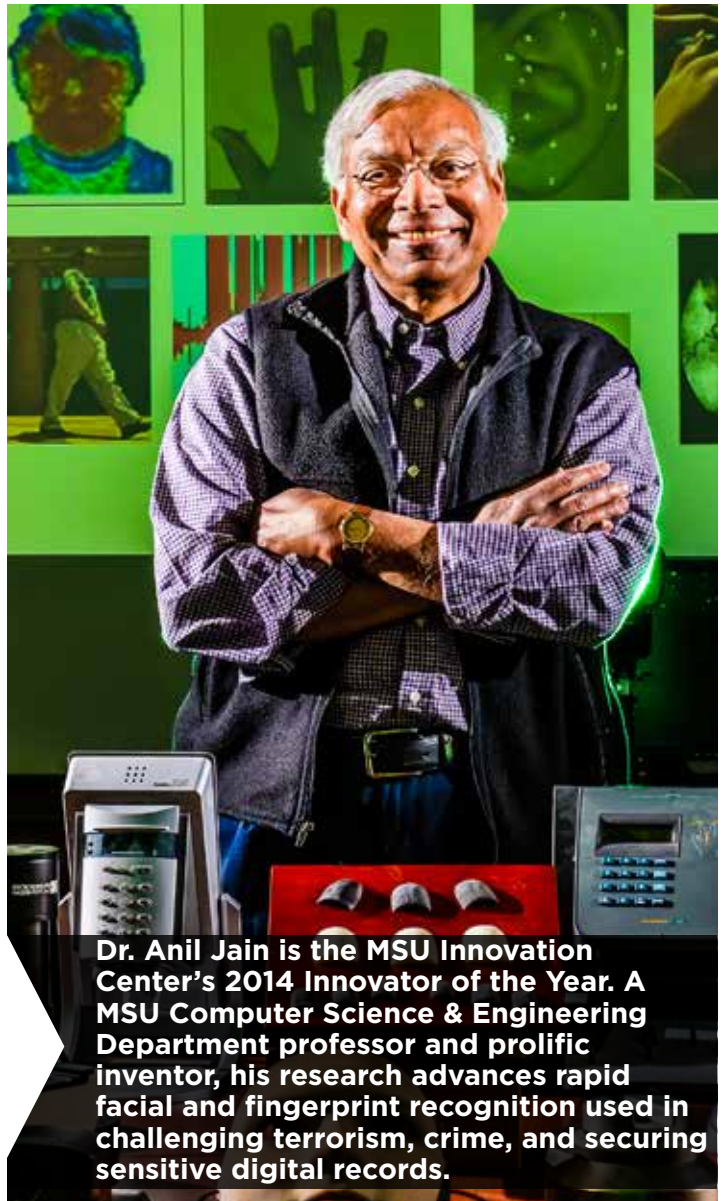

Dr. Anil Jain is the MSU Innovation Center's 2014 Innovator of the Year. A MSU Computer Science & Engineering Department professor and prolific inventor, his research advances rapid facial and fingerprint recognition used in challenging terrorism, crime, and securing sensitive digital records.

**MICHIGAN STATE
UNIVERSITY**

**innovationcenter.msu.edu
517-884-2370 | @MSU_Innovation**



Rotational Development Programs

Success stories don't just happen. They are made.



BOSCH

Invented for life

About the programs:

Bosch offers two rotational development programs:

- ▶ Professional Development Training (PDT) Program for Bachelor's level graduates
- ▶ Junior Managers Program (JMP) for Master's level graduates

The programs consist of four rotations designed to provide cross-functional and cross-divisional opportunities. With input from executive mentors and program coordinators, rotations are custom designed based on business needs and individual career development goals. Assignments can take place in various Bosch locations across the U.S. and abroad, including in corporate offices, technical centers and manufacturing facilities.

What's in it for you?

- ▶ Gain exposure to **different roles** within your field and cross-functionally
- ▶ Build a robust professional **network** across all levels of the organization
- ▶ Gain **international** work experience
- ▶ High **visibility** and senior leadership exposure
- ▶ **Drive your own career**

What makes a good candidate?

- ▶ Relevant Bachelor's or Master's degree received within the last 36 months
- ▶ Minimum GPA: 3.0 PDT and 3.2 JMP
- ▶ Minimum one completed internship/co-op experience, or at least six months full-time, relevant work experience related to your field of study
- ▶ Excellent verbal and written communication skills
- ▶ Demonstrated initiative and leadership abilities
- ▶ Geographic flexibility
- ▶ Authorized to work in the U.S. and do not require sponsorship now or in the future

Apply now: www.boschcampus.com



Join us on Facebook & LinkedIn

facebook.com/boschcampus
linkedin.com/company/robert-bosch-north-america

In order to satisfy requirements for the U.S. Department of Labor and the Office of Federal Contract Compliance Programs, you must complete Bosch's online application in order to be considered for employment. Bosch is fully committed to Equal Employment Opportunity and to attracting, retaining, developing and promoting the most qualified associates regardless of race, gender, national origin, religion, sexual orientation, age, disability, veteran status, genetic information or any other characteristic protected by state or local law.



ME 371
Mechanical Design I
Dr. Assaad Alsahlani
Academic Specialist
Department of Mechanical Engineering

Thrills for Pre-collegiates: Mechanisms that Fascinate, Captivate, Stimulate and Entice

Teams of students were required to design and manufacture mechanisms that would thrill an audience of pre-collegiate students. The constraints imposed upon this assignment were that each mechanism must incorporate at least one linkage, one gear set and one cam-follower combination. These engineering marvels will be demonstrated and displayed with a complementary poster explaining the subtleties of each mechanism. The ME 371 teams will also be interviewed and rated by the pre-collegiate students. The most highly-rated team will be awarded the Sparty Plaque, which was designed and fabricated by students at Holt Junior High School over a decade ago.

Teams and members: Section 1

Team 1	Team 2	Team 3	Team 4	Team 5	Team 6
Daniel Cornelius	Alvin Chiang	Abdulrahman Alsuwaylim	Avinash Dutt	Rebekah Domke	Christine Hampton
Curtis Coscarelly	Brice Furr	Jonathan Bianchi	Brandon Leblanc	Tyler Ellsworth	Matthew Igo
Robert Morgan	Ping Hsiung	Christopher Churay	Tim Mijnsbergen	Lucas Johnson	Kevin Lalko
Zachary Tuller	Steven Price	Haoyu Wang	Andrew Morgott	Vikram Mandelia	Natasha Mital
Eric Waldron	Lance Roth	Tingyuan Zhang	Stephen Saksa	Gerald Rivkin	Connor Montgomery
Michael Wicker					Eric West
Team 7	Team 8	Team 9	Team 10	Team 11	Team 12
Stephanie Dejong	David Bernier	Bashaier Alsinan	Eric Bargiel	Shaoyu Han	Ryan Blancke
Maryrose Jakeway	Taylor Forbush	Evan Bushman	Nicole Bruggema	John Neidhart	Blake Hatherley
Sara Knoedler	Shannon Grace	Naomi Carlisle	Eric Buday	Zhi Phuah	Matthew Maier
Ian Waugaman	Joseph Latorre	Jacqueline Frey	Yash Kankaria	Tim Smith	Benjamin Rowley
	Quinn Putt	Taylor Mullahy	Abhimanyu Singh	Matthew Sutter	
	Charles Pynnonen		Abigail Wulf	Yucheng Wang	

Teams and members: Section 2

Team 1	Team 2	Team 3	Team 4	Team 5	Team 6
Nickolas Aguayo	Daniel Busch	Oluwabukola Ajayi	Luyi Chen	Yu Chen	Alyssa Bartlett
Bingchen Chi	Joseph Genoa	Miriam Chege	Andrew Crechiolo	Michel Giffonisantos	Tobin Egger
Jiewen Huang	Shane Hessling	Chase Gunderud	Zackary Hickman	Ryan Juntunen	Axel Ivers
Ankit Sharma	Jessica Lo	Haochen Li	Zhanying Hu	Yuheng Wang	Alejandro Porras
	Daniel Summers	Shenzhou Xin	Zhengyuan Xie	Yifan Zhao	Prateek Prasad
Team 7	Team 8	Team 9	Team 10	Team 11	Team 12
Cody Bradford	Adam Anderson	Daniel Blair	Nathan Fedewa	Zachary Abbott	Nadia Amira
Alexander Gerding	Nick Chocko	Mark Cogo	Elizabet Gojcaj	Andrew Boyer	James Cuthbert
Sarah Parsons	Andrew Hildner	Zachary Dutcher	Jiajun Liu	Joshua Dewys	John Danielson
Andrea Vedrody	Michael Kron	Tunan Guo	Bradley Trublowski	Anthony Kobak	Daniel Garberding
Renee Wirsing	Sean Raymor	Paul Heeder	Nicholas Vukov	Casey Palanca	



ME 412
Heat Transfer Laboratory

Dr. Neil Wright
Associate Professor of Mechanical Engineering

Thermoelectric Generator

A thermoelectric generator is a solid-state device that produces an electric current when one side is hot and the other cold. This phenomenon is due to the Seebeck effect and does not require moving parts. If implemented in an automobile engine, the exhaust gas and the surrounding air could provide the high and low temperatures, respectively, which enable a thermoelectric generator to recover some of the otherwise wasted energy. In this semester's project, each student group must design and specify or build a fin array or deflector to direct the flow of air from an industrial heat gun onto an array of thermoelectric generators. The challenge is to heat one side of the thermoelectric array quickly, while not exceeding a specified maximum temperature. The electricity generated powers a small motor that raises a weight. The design that raises the weight in the shortest time wins.

Competition Schedule

Time	Station	Team	Team members
8:00	A	20	John Alocilja
	B	13	Travis Packer
8:15	A	12	Toby Buckley
	B	28	Shenyu Gao
8:30	A	17	Jason Avedesian
	B	19	Stephen Marshall
8:45	A	3	Danielle Durocher
	B	5	Yuhao Chen
9:00	A	21	Tianyi Fu
	B	1	Ryan Jacobs
9:15	A	11	Bara Aldasouqi
	B	15	Michael Cieslik
9:30	A	24	Kyle Corey
	B	02	Trent Johnson
9:45	A	9	Ravin Kelsner
	B	31	Rupinder Singh
10:00	A	22	Alexander Bonnen
	B	23	Will Burek
10:15	A	30	Daehee Park
	B	29	Evan Meier
10:30	A	10	David Drake
	B	14	Eric Bambach
10:45	A	6	Shadi Jammoul
	B	8	Ryan Ferguson
11:00	A	7	Zachary Averill
	B	16	Anna Nahm
11:15	A	25	Lauren Grigg
	B	18	Jill Furness
11:30	A	27	Ralang Argi
	B	26	Austin Daugherty
11:45	A	4	Michael Campbell

ME 471 Mechanical Design II



Dr. Farhang Pourboghraat
Professor of Mechanical Engineering



Dr. Patrick Kwon
Professor of Mechanical Engineering

Pick & Place

Student teams design, build, and test a device to pick up two objects (separately or simultaneously) from their rest positions (a), move them over a wall; and rotate and place the objects on targets (b). The winning device is the one with the least weight which performs these tasks most quickly and accurately. Teams may use combinations of electromagnets, mechanical grips, pulleys and other mechanisms, with up to four levers and cranks. The ideal device should have the stiffness and agility to move the objects smoothly with minimal deflection of linkages, without mechanical failure.

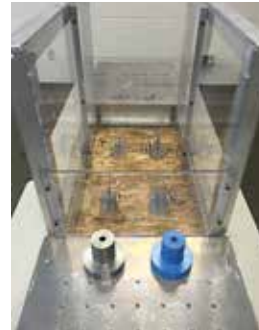

a)

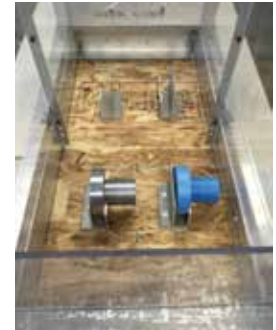

b)

Time	Team	Station	Team members
8:30	1	A	Katherine Arends, Julian Diaz, Qin Liu, Scott Matthews, Jay Thanedar
	1	B	Abdulmajeed Alotaibi, Alexander Hoover, George Lewis, Philip Skinkle, Shenquan Wang
8:40	2	A	Sanders Aspelund, Julia Briggs, Ryan Dutour, Kyle Medrano, Michael Thelen
	2	B	Michael Doa, Aimee Griffin, William Kang, Tyler Karp, Isabel Rittstiege, Robert Warfield
8:50	3	A	Jason Avedesian, Lindsay Clark, Omar Elsherif, Harsh Patel, Davis Trapp
	3	B	Micah Appel, Ryan Kutcher, Mark Taylor, Qin Wu, Libin Ye, Yijia Zhang
9:00	4	A	Angel Begov, Lucia Delvillano, Dylan Etheridge, Sapan Patel, Aleksandr Vartanian
	4	B	Tyler Gallant, Horitsu Kubata, Philip Lecznar, Michael McKinley, Jacob Vymazal
9:10	5	A	Daniel Bowers, Kimberly Fortenberry, Alexander Friedman, Bradley Seegert, Patrick Vaughan
	5	B	Benjamin Allen, Dominique Dubay, Jay Gersonde, Matthew Klooster, Amanda Sliney, Kyle Witgen
9:20	6	A	Evan Boyers, John Gillis, Laura Gumper, Daniel Seiderman, Dominic Waldorf
	6	B	Evan Flynn, Nathan Gill, Bradly Labaere, Alan Richards, Haocheng Sun
9:30	7	A	William Burek, Jeffrey Hilk, Jennifer Jones, Joseph Senechal, Xuelai Wang
	7	B	Maxwell Bennett, Graham Goble, Andrew Stieber, Alexander Taylor, Shane Toreki
9:40	8	A	Robert Cenowa, Peter Howes, Kathleen Landwehr, Rupinder Singh, Scott Welburn
	8	B	Ryan Glynn, Gregory Peterson, Lee Teasley, Cody Thon
9:50	9	A	Kane Clark, Dingyu Hu, Ying-Hung Lou, Andrew Slatin, Koreco Wilkins-Webster
	9	B	Katherine Donnay, Collin Hartman, Mauricio Pereiramagalhaesnsanto, Kevin Pugh, Jun Sheng
10:00	10	A	Ryan Clark, Daniel Ignatowski, Aaron Smith, Darby Spiegel, Robert Wygant
	10	B	Fenykumar Patel, Katelyn Sabo, Jiayi Shi, Andrew Stanney, Hengyun Wan
10:10	11	A	Keegan Connolly, Yan Li, Kristopher Meier, Logan Springgate, Robert Zuerlein

Weigh Team Projects (8:00 a.m. - 8:30 a.m.)

Break (10:20 a.m. - 10:40 a.m.)

Third Place Competition (10:40 a.m. - 10:50 a.m.) - #3 vs #4

First Place Competition (10:50 a.m. - 11:00 a.m.) - #1 vs #2



ME 478 Product Development

Dr. Patrick Kwon
Professor of Mechanical Engineering

Stair Climbing Vehicle

The main objective for the course is to design and produce a stair-climbing vehicle for the track announced in class while integrating the engineering knowledge gained during the students' engineering education at MSU. Starting from an individual project and progressing to a team project, each team must produce a stair-climbing vehicle through a series of design and manufacturing tasks. Each student needs to contribute individually as well as collaboratively to accomplish a series of tasks with CAD/CAM packages, CNC machining, rapid prototyping, testing, etc.

Teams and Members

ATT

Evan Norquist
Jinyang Qiu
Argi Ralang
Jeff Tatum
Basil Thurston



StairMaster Robotics

Eddie Franklin
Keith Leonard
Arthur Paquier
Steven Utz
Nick Youngerman

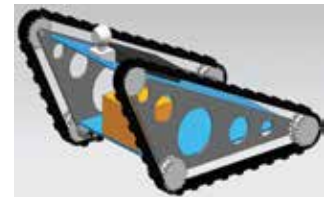

Multi-Trac

Daniel Bowers
Ryan Glynn
Dan Ignatowski
Jake Sparks
Shane Toreki

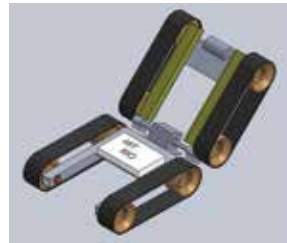

StairMaster.SC7

Dylan Etheridge
Dinhyu Hu
Greg Lott
Bradley McCauley
Aaron Smith

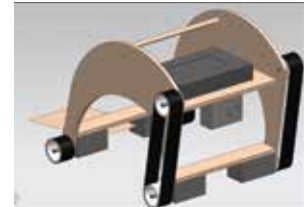

SCAR-HT

Ryan Jacob
Jacob Kramer
Grant Ridley
Barrett Winrick



Team Bigfoot

Kyle Corey
Tyler Finses
Jill Furness
Ravin Kelser
Nick Theis



Sir Edmund

Angel Begov
Kevin Betts
Katie Donnay
Kimberly Fortenberry
John Gillis

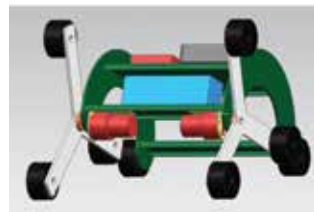

ME 491 International Humanitarian Engineering



Dr. Brian Thompson
Professor of Mechanical Engineering

W. H. Welch, MD (1850 – 1934) founder of the School of Public Health at Johns Hopkins University in Baltimore, Maryland, wrote, “It is a well known fact that there are no social, no industrial, no economic problems which are not related to health.”

Dr. Welch’s profound remark buttresses and sustains the vision of an international educational initiative launched over a decade ago at MSU, through single semester interdisciplinary humanitarian projects that can motivate and accelerate undergraduate learning more poignantly than traditional academic programs. This semester’s projects are concerned with:

- Launching an entrepreneurial recycling initiative featuring a human-powered machine that cleans and shreds plastic containers from Guatemala City’s garbage dumps.
- Establishing a micro-enterprise at an orphanage in Panyebar, Guatemala, based on a solar-thermal structure that dehydrates fruit and vegetables to nourish children, to reduce post-harvest losses, and to generate income.

The fabric of this design-intensive inter-disciplinary course is woven from a thread of ideas on humanitarian societal development that addresses the needs of the 80 percent of the world’s population who live on less than US \$2 each day. Students enrolled in this ME 491 course address the challenges of creating new products that enhance the lives of the poor, while respecting their social, cultural and ethical identities. So, on Design Day, please stop to review the innovations developed by these ME 491 students and consider joining them in serving the billions of men, women, and children who, through no fault of their own, are living in abject poverty.

In September 2014, the United Nations Goodwill Ambassador Emma Watson delivered a speech in New York City and concluded with the following string of words, “I’m inviting you to step forward, to be seen, and to ask yourself: If not me, then who? If not now, then when?” Will you step forward? Will you join the throng that serves the poor? Really, will you help?

These ME 491 Projects were generously sponsored by Whirlpool Corporation



Appropriate Technology Collaborative: Human Powered Plastic Recycler

“Give a man a fish and you feed him for a day; teach a man to fish and you feed him for a lifetime.” This quote, by Confucius, is the philosophy of Appropriate Technology Collaborative (ATC). ATC is a non-governmental organization (NGO) in San Marcos La Laguna, Guatemala. Its mission is to empower low income communities through technology that improves the quality of life. This particular project builds upon a pre-existing trade, where local residents currently make a living by gathering and sorting raw plastic, then selling it to recycling plants to be processed at a low profit margin. ATC’s vision is to bring recycling processes into a local facility owned by the village, where plastic materials can be processed on-site. In addition, this project will empower Guatemalan women by providing them with dignified jobs. On-site processing of plastic materials will provide the opportunity to create plastic injection molded products and filament for 3D printing, a growing industry worldwide.



The first step in this process is shredding the plastic into flakes followed by cleaning the flakes using environmentally safe methods. If the cleaned and shredded plastic cannot be utilized in the local facility, it will be sold to off-site facilities for double the price of raw uncleaned plastic. Although industrial shredding systems and cleaning equipment are available in Guatemala, the high cost and energy demands are impractical for this application. The goal of our project is therefore to design and build a human-powered plastic shredder, and to develop an environmentally safe method for cleaning the plastic. Designs must be reproducible in Guatemala using only locally available resources.

Our team believes that the focused efforts of a small group of dedicated individuals can make significant changes to the world. By utilizing clean, efficient, human-powered recycling methods, based on mechanisms like bicycles, Guatemalan locals can dramatically enhance both their environmental and economic conditions. The production of a bicycle powered plastic recycler could not have been accomplished without the financial support of Whirlpool Corporation and guidance from MSU faculty and ATC staff.



The Appropriate Technology Design Collaborative



Michigan State University

Team Members (left to right)

Leo McLaughlin
West Bloomfield, Michigan

Andre Paquier
Midland, Michigan

Micah Appel
Traverse City, Michigan

Mark Taylor
Walled Lake, Michigan

Appropriate Technology Collaborative

Project Collaborators

John Barrie
Ann Arbor, Michigan

Lori Hart
Ann Arbor, Michigan

Monika Goforth
San Marcos La Laguna,
Guatemala

Appropriate Technology Collaborative: Panyebar Nutrition Center–Solar Powered Fruit Dehydrator

The diets of children in many parts of the world do not contain sufficient micronutrients. As a result of this malnutrition their growth is stunted, which hinders proper development. Panyebar Education and Nutrition Center in Guatemala is managed by Monika Goforth who assists in educating and feeding young children. The region produces foods with the required micronutrients, but only when certain fruits are in season and it is too costly for them to import them at other times.

Guatemala suffers as one of the most micronutrient-deprived countries in the world and as the worst in Latin America. The food supply is often affected by natural disasters such as hurricanes, floods, erosion and deforestation. Panyebar, Guatemala is an isolated village populated primarily by landless peasants who work on nearby plantations farming coffee and sugar. Children here struggle with malnutrition and often become stunted in their growth because they do not consume the required vitamins. Children also become sluggish, have low energy and have difficulty learning or even playing. A solar fruit dehydrator would therefore be beneficial for storing more nutritious foods and creating a means of income.

The MSU team plans to build a solar fruit dehydrator to provide nutritious foods year-round and to provide a new means of income for the Education Center. The solar dehydrator will utilize free energy and incorporate thermal mass to increase the efficiency of the fruit dehydrating system. Upon completion of the project, a manufacture and assembly process will be written so that the solar dehydrator can be reproduced easily.



The Appropriate Technology Design Collaborative



Michigan State University

Team Members (left to right)

Seth Rohr
Otsego, Michigan

Lisa Vogel
Williamston, Michigan

Nick Youngerman
Troy, Michigan

Appropriate Technology Collaborative

Project Collaborators

John Barrie
Ann Arbor, Michigan

Lori Hart
Ann Arbor, Michigan

Monika Goforth
San Marcos La Laguna,
Guatemala



ME 497
Biomechanical Design
Dr. Tamara Reid Bush
 Assistant Professor of
 Mechanical Engineering



MKT 420
New Product Development
Dr. Hang Nguyen
 Assistant Professor of Marketing
 Business College

Biomechanical Design and New-Product Development

The Biomechanical Design and New-Product Development course (ME 497/MKT 420) provides students with a unique opportunity to develop and market a real, new product that incorporates some biomechanical function. This class is novel insofar as students work in inter-disciplinary teams of engineers and marketers---the only class in the ME curriculum that offers this teaming interaction. Students experience the entire process of new product development, from opportunity identification, concept generation and testing, to product development, design analysis and launch. This course further strengthens students' knowledge and real world exposure by working with Spartan Innovations and entering local innovation competitions.

Teams and Members

#	Team members	Team Slogan
01	Sean Hughes, Stephanie Jones, Krista Oldham, Davis Trapp, Zachary Tuller	Go Ramp – an onboard, deployable wheelchair ramp
02	Hayden May, Jessica O'Brien, Jiamin Qiu, Nicholas Scibilia, Yahang Zhang	The Dish Roller – a hand crank mechanical dishwasher
03	Julia Briggs, Suxin Deng, Laura Gumper, Chase Gunderud, Sha Li	Slide 'n Recline Bath Bench – a sliding bath transfer device for individuals with limited mobility
04	Ashley Melnick, Emily Sciriha, Adam Toothaker, Austin Trethewey, David Zilinskas	Coat Master – the premier device for hanging and organizing all of your clothing needs
05	Benjamin Carruthers, Emma Drenth, Jeffrey Hall, Zachary Ruffin	Top Shelf – you're never too short to use the top shelf; easy, accessible, storage
06	Evan Bushman, Rachel Geary, Kelly Munzenberger, John Stando, Renee Wirsing	Make Reaching Your Feet an Easy Feat – the solemate allows you to easily reach your feet while you are seated
07	Alvin Chiang, Richard Harrington, Patrick Michaels, Bradley Morgan, Darrell Waldon	ParTee – multi-loaded mechanical golf and tee precision height placing device
08	Mengting Chiang, Connor Mckinney, Daniel Summers, Patrick Walsh, William Weiland	The Dookie Dude – picks up, bags and easily disposes of pet waste
09	Conrad Bartke, Michael Bell, Tyler Cook, Patrick Vaughan, Ryan Volkman	Mobilift – assist, transfer, lift and sync
10	Zachary Abbott, Eric Buday, James Cuthbert, Jessica Knapp, Kelli Zorn	Spatter Guard – easy to clean automated splatter prevention tool that contains microwave food mess
11	Avinash Dutt, Hannah Fleming, Logan Springgate, Arielle Viviano, Benjamin Yancho	Stowable Lapdesk – designed to easily attach to lofted beds, close securely, and safely retract to store your belongings
12	Trevor McSween, Bansari Patel, Thomas Stevenson, Cody Thelen	The Solution – hands-on mechanical learning kits to challenge and engage students in math and science
13	Trevor Laskowski, Bradley Sauchak, Matthew Sylvester, Scott Welburn	The Lift Assist – safely and easily raise and lower objects to and from their “out-of-reach” storage space
14	Stheffn Borgg Reis de Almeida Freitas, Jian Hu, Prateek Prasad, Mitchell Williams	Smart Desk
15	Bara Aldasouqi, William Burek, Katheryn Ford, Conor Klerekoper, Philip Skinkle	SimPill – an easy-use pill dispenser
16	Alisa Bennett, Chelsea Didio, Aimee Griffin, Trent Johnson, Ethan Welzbacker	Gentle Lift Crib – to all the moms; we've got your back!
17	Sarah Coleman, Jeffrey Malnor, Samuel Schira, Lucas Steele, Chunlei Zhao	Por-Table – take work on the go!
18	Joshua Cresswell, Alexandra Howe, Nicholas McCafferty, Megan Simpson	Egro Food Finder – the pantry that comes to your level

The Capstone Projects



Dr. Giles Brereton
Associate Professor of
Mechanical Engineering

Presentation Schedule – Room 1202

Time	Team Sponsor	Project Title
8:30 a.m.	Ingersoll Rand	Air Conditioner Packaging Cost Reduction
9:00 a.m.	Ingersoll Rand	Improved Design of Roof Panel Assemblies
9:30 a.m.	Ingersoll Rand	Cost-Effective Impeller-Mount Design
10:00 a.m.	U.S. Steel	Improved Thermal Efficiency in Bottle Cars
10:30 a.m.	U.S. Steel	Cover for a Hot Metal Transfer Car
11:00 a.m.	Robert Bosch	System to Measure Axial Play in a Throttle Shaft
11:30 a.m.	DTE Energy	System to Analyze Precipitator Performance



To view these presentations live please visit the Design Day website: <http://designday.egr.msu.edu> and click the *Watch Live* tab in the left-side menu bar.

ME 481 Mechanical Engineering Design Projects

ME 481 is a required course for mechanical engineering majors at MSU. The course provides students with a team-based capstone design experience in which they:

- Use the technical expertise, communication skills, and teaming methodologies they have learned throughout their mechanical engineering curriculum, together with their creativity, to solve real world problems
- Collaborate with practicing engineers to address problems sponsored by industry
- Develop new products or re-design existing products to reduce costs or enhance reliability
- Interact with large, medium, and small companies in the automotive, defense, aerospace, consumer products, interior design and material processing industries.

We gratefully acknowledge the support of this semester's project sponsors: ArcelorMittal, Robert Bosch, Consumers Energy, DTE Energy, Eaton Aerospace, EMD Technologies, Fiat Chrysler, Ford Motor Company, General Motors Foundation, Gilbarco Veeder-Root, IAC International, Ingersoll Rand, Kautex Textron, Meritor, US Steel, and Whirlpool Corporation; and our educational partners at Melvin Millet Learning Center and Mid-Michigan Children's Museum.

Ingersoll Rand

Air Conditioner Packaging Cost Reduction

Trane, a subsidiary of Ingersoll Rand, is one of the world's leading manufacturers of air conditioning systems. Each year it ships from the Trane, Lynn Haven facility approximately 24,000 D-sized cabinets (89" x 65" x 41"), each of which must be packaged securely—usually in wooden crate assemblies. In 2009, a sharp increase in the cost of lumber resulted in a corresponding spike in packaging costs. Currently, the cost of packaging for each D-sized cabinet air conditioner is \$73. Trane is interested in reducing this packaging cost to avoid increasing the overall product cost and to remain competitive in this market.

The Michigan State team has been asked to design a packaging system which reduces packaging costs to \$55 per unit, through changes in the materials used and modifications to the packaging structure. Design options will be created and analyzed using finite element methods to determine the most promising option. The final design must also comply with National Motor Freight Traffic Association guidelines.

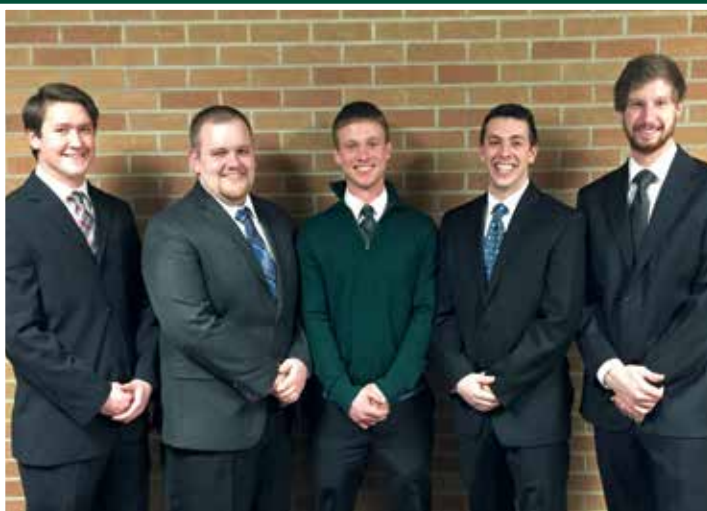

Michigan State University Team Members

Alex Bonnen
Wixom, Michigan

Andrew Gates
Shelby Township, Michigan

John Hardy
North Muskegon, Michigan

Kevin Licata
Sterling Heights, Michigan

David Thomas
Clarkston, Michigan

Ingersoll Rand Project Sponsors

Mark Bell
Panama City, Florida

Devin Tate
Panama City, Florida

Douglas Uzarski
Panama City, Florida

ME Faculty Advisor
Brian Thompson

Ingersoll Rand

Improved Design of Roof Panel Assemblies

Trane, a division of Ingersoll Rand, is one of the world's largest manufacturers of air conditioning systems, services, and solutions, providing cool air, warm air, or clean air for people in residential, commercial, industrial and institutional buildings. Air conditioning units are often bulky and comprise several structural components, one of which is the roof panel. During assembly of these units, the roof panel must be installed with great care if it is to be done properly and safely. Currently these panels are moved using a vacuum suction manipulator, which can be unreliable. Manipulators are used to pick up the roof panel from a table, move it into place, and lower it on top of the unit, after which an operator secures it with screws. However, if the suction manipulator functions incorrectly, the roof panel can fall to the ground. Trane would like to eliminate the possibility of suction-manipulator failure, as safety is the top priority at Ingersoll Rand.



The objective for the MSU team is to improve the current manipulator design, possibly using new technologies, to ensure eliminating the possibility of suction-manipulator failure. An optimal solution will be selected which fulfills Trane's constraints and can be implemented in the assembly process to provide the same functionality in a reliable and safe manner.

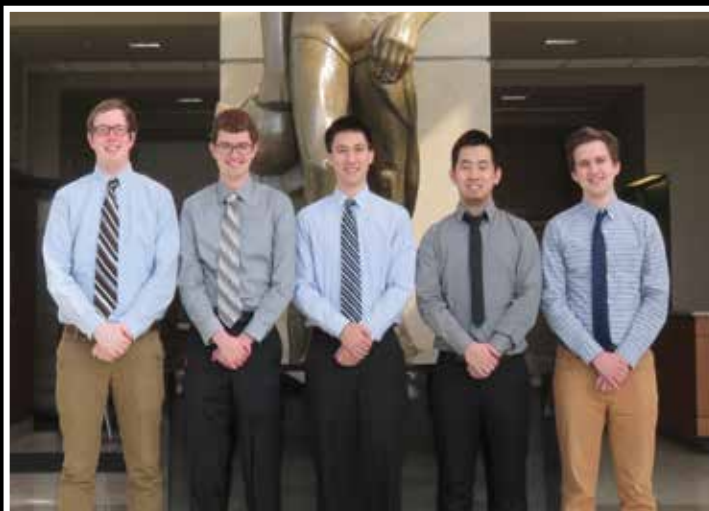

Michigan State University

Team Members

David Drake
Troy, Michigan

Austin Trethewey
Rochester, Michigan

Mitchell Williams
Troy, Michigan

Chunlei Zhao
Beijing, China

David Zilinksas
Milford, Michigan

Ingersoll Rand

Project Sponsors

Dale Byers
Lexington, Kentucky

Rod Neely
Lexington, Kentucky

ME Faculty Advisor
Ranjan Mukherjee

Ingersoll Rand

Cost-Effective Impeller-Mount Design

Trane Incorporated, a subsidiary of Ingersoll Rand, is a world leader in air conditioning, heating, and ventilation systems. Trane provides high quality climate control systems for residential, commercial, industrial, and institutional buildings. One product for industrial and commercial use is a 'Performance Climate Changer,' which is essentially a very large air conditioning unit. Large centrifugal fans are utilized to draw air into the performance climate changer prior to cooling. Cooled air is then distributed through the building via a system of ducts. Trane is interested in making this design more flexible by hanging the centrifugal fans vertically, thereby providing a better installation option for buildings with limited floor space.

The goal of this assignment is to provide this installation option by designing an airtight mounting system that can support a 130 lb motorized impeller, withstand its vibrations, and allow rapid installation. The mount must meet Trane's quality standards and be cost-effective, as it is expected to be manufactured in large volumes. The team will build a working prototype, test its performance, and demonstrate its capability for vertical mounting of impellers.



Michigan State University

Team Members

Nicholas Decker
Rochester Hills, Michigan

Brad McCauley
Rochester Hills, Michigan

Anna Nham
Troy, Michigan

Mariya Titova
Berkley, Michigan

Kevin Viguilla
Higgins Lake, Michigan

Ingersoll Rand

Project Sponsor

Mike Lewis
Lexington, Kentucky

ME Faculty Advisor
Abraham Engeda

U.S. Steel

Improved Thermal Efficiency in Bottle Cars

U.S. Steel is one of the largest steel producers in the United States. To produce steel in one particular plant, iron ore is melted in a blast furnace and then transported in a “hot metal bottle” train car to a secondary facility where it is then mixed with other elements, reheated, and transformed into steel. At the U.S. Steel plant in Ecorse, Michigan, the molten iron is moved three miles in a bottle car with a large opening (for filling and emptying), resulting in a significant loss of heat from both the molten iron, on the outward journey, and the bottle car’s insulating “refractory brick” inner surface on the return trip. U.S. Steel wishes to conserve as much heat as possible within the hot metal bottle cars, without hindering the steel loading and unloading processes.



The goal of the Michigan State design team is to develop a lid that will function as an insulator and preserve as much of the heat within the hot metal bottle cars as possible. The lid must be designed to be safe and easy to use, to ensure that there are no unnecessary delays in the transportation of the steel, and the iron does not cool excessively inside the metal bottle. A prototype of the final design will be analyzed and tested for potential implementation by U.S. Steel.



Michigan State University
Team Members

Kevin Betts
Hendersonville, Tennessee

Austin Daugherty
Dexter, Michigan

Stephen Marshall
Saline, Michigan

Ryan O’Sullivan
Saline, Michigan

Alex Schuen
Grand Rapids, Michigan

U.S. Steel
Project Sponsors

Todd Albring
Ecorse, Michigan

Martin Beaver
Ecorse, Michigan

Abigail Bennett
Ecorse, Michigan

Dale Groh
Ecorse, Michigan

ME Faculty Advisor
Sharon Xiao

U.S. Steel

Cover for a Hot Metal Transfer Car

United States Steel Corporation is an integrated steel producer with major operations in the United States, Canada, and Central Europe. Between all locations, U.S. Steel has an annual raw steelmaking capability of 27 million net tons. At their location in Ecorse, MI, molten iron is transported three miles by hot metal cars from the blast furnace to the steel shop. The hot metal cars have a large opening in the center allowing molten iron to be poured in and dumped out. Currently, this hole is uncovered at all times, resulting in a significant loss of heat energy from the molten iron. Previous attempts have been made to create a cover for the hot metal car but all have proved ineffective. U.S. Steel wishes to create a reusable, removable cover in order to retain heat inside the hot metal car, which will reduce the amount of energy required to reheat the molten iron to the required temperature when it reaches the steel shop.

The MSU team will carry out a heat-transfer analysis of this cooling process and design a cover for the hot metal car that can operate in a confined space and withstand extreme temperatures, without interrupting day-to-day steel production. When the optimized design is completed, it will be manufactured and tested at U.S. Steel on the hot metal cars.



U. S. Steel



Michigan State University

Team Members

Danielle Durocher
Brownstown, Michigan

Aidan Hunter
Dearborn, Michigan

Tyler Jezowski
Linwood, Michigan

Connor Koester
Clinton, Michigan

Adam Lyman
DeWitt, Michigan

U.S. Steel

Project Sponsors

Todd Albring
Ecorse, Michigan

Marty Beaver
Ecorse, Michigan

Abigail Bennett
Ecorse, Michigan

Dale Groh
Ecorse, Michigan

ME Faculty Advisor
Giles Brereton

Robert Bosch

System to Measure Axial Play in a Throttle Shaft

Bosch is an international engineering and electronics company which sells products to a large number of different industries. One particular automotive product—the Electronic Throttle Body (ETB)—is tested at the Farmington Hills, MI, facility for customers throughout the world. An ETB is a component responsible for controlling airflow through a throttle valve to the engine in both gasoline port fuel injection and direct injection vehicles. Because of manufacturing tolerances, a certain amount of linear displacement of the throttle shaft and plate is allowed within the cylindrical housing. Measurement of this movement or “axial play” is currently carried out before and after durability tests to ensure that the movement complies with customer specifications. However, the current test setup and run time is long and complicated and requires removing material from the throttle body housing so that an ETB can only be tested according to this procedure once.

The goal of this project is to design and build a test fixture and procedure that allows measurement of the axial play of the throttle plate in a simpler and faster way. To meet Bosch’s specifications, the displacement of the throttle rod must be measured with one micron accuracy when a prescribed force is applied in both the positive and negative axial directions. A modular fixture will be designed, fabricated and delivered to Bosch for evaluation.

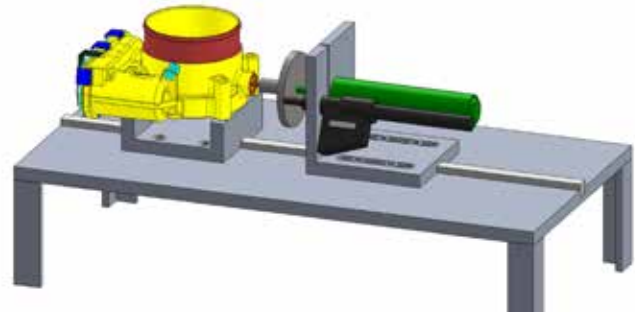

BOSCH

Invented for life



Michigan State University

Team Members

Amelia Karaba
North Muskegon, Michigan

Travis Packer
Fowlerville, Michigan

Megan Simpson
Macomb, Michigan

Jacob Sparks
Dearborn, Michigan

Dane Spillman
Sterling Heights, Michigan

Robert Bosch

Project Sponsor

John Cook
Farmington Hills, Michigan

ME Faculty Advisor
Brian Feeny

DTE Energy

System to Analyze Precipitator Performance

DTE Energy is located in Detroit, MI, and provides gas and electricity services to over three million residential, business and industrial customers within Michigan. To provide these services, DTE Energy maintains a wide range of energy-producing facilities, such as power stations. In the exhaust gas system of its Trenton Channel facility, an electrostatic precipitator is used to clean exhaust gas by trapping and removing dust particles from the exhaust-gas flow and help meet emission regulations for coal-burning power generation. The precipitator plates require periodic cleaning by mechanically shaking or 'rapping' to maintain their effectiveness. DTE Energy is interested in building a decision analysis system to monitor the effectiveness of electrostatic precipitator cleaning by rapping and to schedule their maintenance to provide the most effective particle removal with the least maintenance cost.

The MSU team will design an online measuring system to acquire data on rapping effectiveness using an accelerometer attached to the rapper's shaft. The data will be fed into a MATLAB decision analysis system, filtered, and used to infer the effectiveness of that particular rapper section. A pilot scale model, based on the Trenton Channel Unit 9 precipitator, will be built and tested.

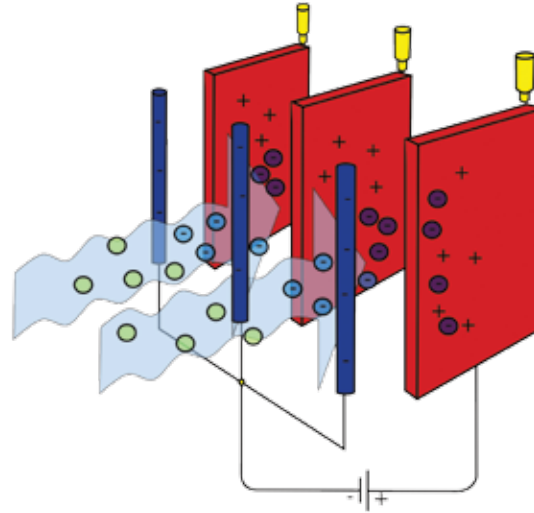

DTE Energy
Know Your Own Power™

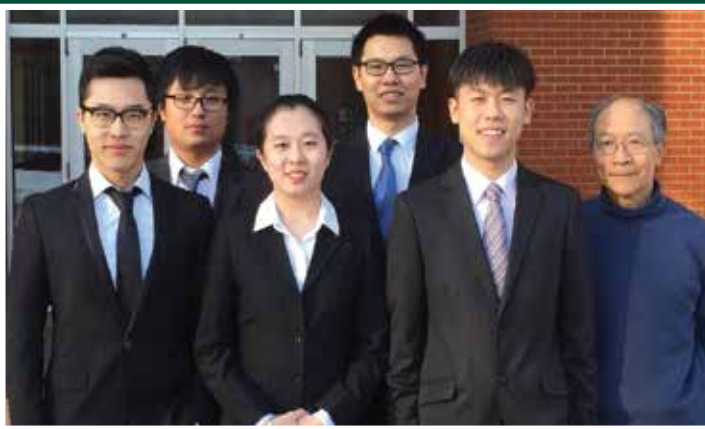

Michigan State University

Team Members

Tianyi Fu
Nanjing, Jiangsu, China

Shenyu Gao
Anyang, Henan, China

Xue Jiang
Luoyang, Henan, China

Kuan-Ying Tao
Taipei, Taiwan

Pengjie Zhuang
Suzhou, Jiangsu, China

DTE Energy

Project Sponsors

Tony Ali Bazzi
Trenton, Michigan

Mohamad Ali Mussa
Trenton, Michigan

Ali-Akbar Shdid
Trenton, Michigan

ME Faculty Advisor
Dahsin Liu

The Capstone Projects



Dr. Giles Brereton
Associate Professor of
Mechanical Engineering

Presentation Schedule – Room 1208

Time	Team Sponsor	Project Title
8:30 a.m.	Eaton Aerospace	Fixture for Measuring Skewed Roller Bearing
9:00 a.m.	EMD Technologies	Smart Braking System for Strollers
9:30 a.m.	Fiat Chrysler	Design of a Compliant Fascia Support
10:00 a.m.	ArcelorMittal	Design of a Secure Facility Entry Gate
10:30 a.m.	Robert Bosch	Test Bench for Natural Gas Injector
11:00 a.m.	Ford	Pressure-Reactive Piston Engine
11:30 a.m.	Gilbarco Veeder-Root	Redesign of a Display Subassembly



To view these presentations live please visit the Design Day website: <http://designday.egr.msu.edu> and click the *Watch Live* tab in the left-side menu bar.

Mechanical Engineering Design Program

Mechanical engineers make the world move and provide the energy for it to do so. One goal of the MSU Mechanical Engineering Program is to educate engineers who are prepared to lead, create, and innovate as their professional or graduate careers evolve. The Mechanical Engineering Design Program is the key element of the curriculum that supports this goal. There are five required design courses in the program which provide our students with eight hands-on, team-based, ‘design, test and build’ projects, and numerous opportunities to practice and refine their written, oral, poster, and video presentation skills. The Design Program in Mechanical Engineering has attracted national recognition on many occasions and helps to distinguish the ME program as one of the best in the country.

The ME faculty who supervised ME 481 design teams this semester are: Ron Averill, Seungik Baek, André Bénard, Giles Brereton, Jongeun Choi, Alex Diaz, Abraham Engeda, Brian Feeny, Farhad Jaber, Dahsin Liu, Norbert Mueller, Ranjan Mukherjee, Rod Tabaczynski, Brian Thompson, Elisa Toulson, Indrek Wichman, Neil Wright and Sharon Xiao.

Eaton Aerospace

Fixture for Measuring Skewed Roller Bearing

Eaton Corporation provides energy-efficient solutions to help its worldwide customer base manage electrical, hydraulic and mechanical power in a more efficient, safe and sustainable manner. Eaton's Aerospace division specializes in flight control systems for military and commercial jet customers. These systems use actuators to control the motion of flaps, slats, and doors on aircraft. Overloading these actuators causes detrimental damage to either the actuator or the adjacent aircraft structure. To prevent overloading, single and multi-plate skewed roller assemblies are used. These skewed roller assemblies limit the force and torque experienced by the flight control system by adding friction to the system. Thus, understanding precisely how much friction a skewed roller assembly adds to a flight control system is essential.

The MSU team will focus on characterizing the coefficient of friction of a skewed roller assembly by designing and building a test fixture to allow accurate measurements of the coefficient of friction under different operating conditions. With a better understanding of the coefficient of friction, Eaton can optimize the design of their flight control systems and reduce the total weight of aircraft components. The success of this project should have a significant impact on Eaton's future designs.



Michigan State University

Team Members

Reema Al Dhaneem
Al Qatif, Saudi Arabia

Ben Carruthers
Dexter, Michigan

Emma Drenth
Williamston, Michigan

Matthew Heimonen
Portage, Michigan

Kyle Sherman
Grand Rapids, Michigan

Eaton Aerospace

Project Sponsor

Andrew Laskov
Grand Rapids, Michigan

ME Faculty Advisor
Alex Diaz

EMD Technologies

Smart Braking System for Strollers

EMD Technologies is a product development engineering design firm based in Addison, Illinois. EMD's focus is "making dumb products smarter" through the use of smart technology. One of EMD's current in-house projects is the "Guardian Angel" line of products. EMD is using smart technology to create "actively safe" products for infants and children. The first Guardian Angel product is a home power outlet with sensor technology that prevents injury from foreign objects entering the outlet. EMD is planning to expand its product line to include an improved stroller design with an automatic braking system that engages when a parent removes his or her hand from the stroller handle. The sensor technology to engage and disengage the brake has been developed and implemented. However, EMD has been dissatisfied with the reliability and robustness of the mechanical brakes currently deployed with this system.

EMD has asked the MSU design team to develop a more reliable mechanical brake to interface with their sensor-activated automatic locking technology. The requirements for the mechanical brake are: improved reliability and robustness; low energy consumption; modularity with other stroller designs; and fast engagement speed. In addition, the brake system must be childproof, quiet and aesthetically pleasing on the stroller structure. The new brake system will be a working prototype that meets all stated requirements and can be demonstrated to stroller manufacturers who may wish to partner with EMD.



COMPLETE INNOVATION

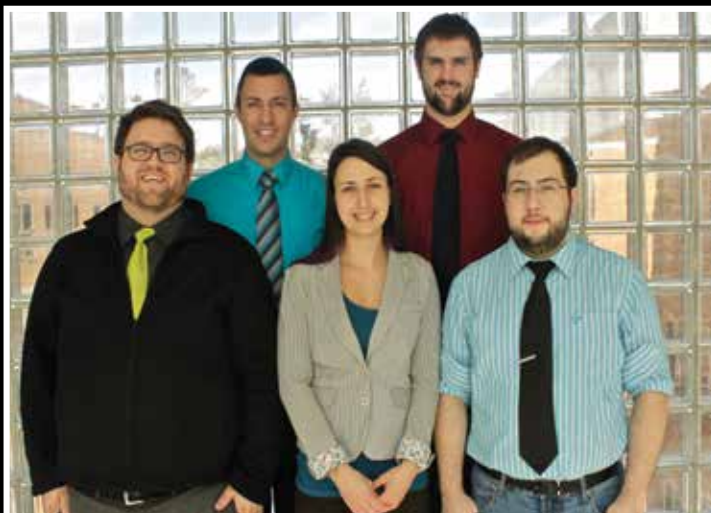

Michigan State University

Team Members

Stephanie Black
Lansing, Michigan

Robert Boomer
Lansing, Michigan

Chris Sehling
Armada, Michigan

Stephen Town
Traverse City, Michigan

Steve Utz
New Berlin, Wisconsin

EMD Technologies

Project Sponsor

Dan Masterson
Addison, Illinois

ME Faculty Advisor
André Bénard

Fiat Chrysler Automobiles

Design of a Compliant Fascia Support

Fiat Chrysler Automobiles (FCA), formed in 2009, is the world's seventh-largest automaker and competes globally, producing automobiles to be driven throughout the world. Since FCA is global, it must manufacture vehicles to meet different regulations for different countries and regions. Vehicle-pedestrian accidents are most common in the more populous European and Asian countries. To minimize injuries resulting from these collisions, the European New Car Assessment Program (Euro NCAP) has created regulations that require vehicle manufacturers to increase the safety of the pedestrian when such an accident might occur. Currently, when a vehicle strikes a pedestrian, the upper leg is often hit by the fascia, many components of which might then collapse. The upper leg may also come in contact with a large, extremely rigid, plastic bracket which may cause severe injury to the pedestrian.

The Michigan State team will help FCA meet the new Euro NCAP regulations for pedestrian upper leg protection by designing a shock-absorbing component to be positioned in the front fascia assembly, between the fascia and the hard plastic bracket. Computer simulated impact tests will be designed and performed to help determine an optimized design of this assembly.



Michigan State University Team Members

Angela Bertolini
Fenton, Michigan

Austin Condra
Hartland, Michigan

Noelle Kahunguba
Ann Arbor, Michigan

Cody Neal
Linden, Michigan

Ashley Pomaville
Macomb, Michigan

Fiat Chrysler Project Sponsors

Rebecca Hannon
Auburn Hills, Michigan

Theron Shaw
Auburn Hills, Michigan

ME Faculty Advisor
Ron Averill

ArcelorMittal

Design of a Secure Facility Entry Gate

ArcelorMittal is the world's leader in steel production and mining and its plants are located all over the world. As a global leader, the company has a strong desire to reduce its carbon imprint on the planet by recycling steel. As recycled steel has become a valuable commodity today, securing the entryway to the recycling and storage facilities to prevent theft has become necessary. Currently, at its Indiana Harbor plant, two guards investigate each entering vehicle by approaching the vehicle and stopping it to validate employee credentials or permits for access to ArcelorMittal property. This process has proved ineffective on some occasions and so ArcelorMittal is exploring other options to secure this entryway. In addition to improving security, ArcelorMittal is also interested in rerouting, repaving and expanding its existing traffic lanes to further smooth the flow of trucking and employee traffic into its recycled-steel facility.

The MSU Engineering team will explore and evaluate different approaches to securing and expanding the entryway using gates and dividers. The most favorable options must meet specified budget and energy conservation requirements. A prototype of the optimal design will then be 3D printed and presented, together with detailed design specifications, to ArcelorMittal.



ArcelorMittal



Michigan State University

Team Members

Tina Isaac
Lansing, Michigan

Matthew Korolew
Grand Rapids, Michigan

Brandon Ogbonnaya
Detroit, Michigan

Manmit Singh
Grand Rapids, Michigan

Saurabh Sinha
Novi, Michigan

ArcelorMittal

Project Sponsor

Cliff Barnett
East Chicago, Indiana

ME Faculty Advisor
Rod Tabaczynski

Robert Bosch

Test Bench for Natural Gas Injector

Bosch is a multinational engineering company headquartered in Stuttgart, Germany, which makes a wide range of innovative products for the automotive, consumer, and industrial sectors. Bosch's automotive technology group supports research and development into natural gas injector systems and their applications. These systems are used to inject fuel into the cylinders of engines, and particularly those used in the domestic trucking market. Currently, Bosch does not have an efficient way of testing the performance of natural gas injectors. It has, therefore, assigned to the MSU design team the task of designing, building and testing a pneumatic test bench on which the performance of natural gas injectors can be analyzed.

The goal of this project is to design and fabricate a prototype test bench that will be used to perform testing of the electro-mechanical functions and measurement of the mass flow per injection of different injectors and injector types, to support other testing programs within Bosch. To achieve this goal, structural design calculations, computational fluid dynamics, and finite element analysis techniques will be performed to ensure the design solution meets the required integrity and safety factors at a minimal weight and cost.



BOSCH
Invented for life

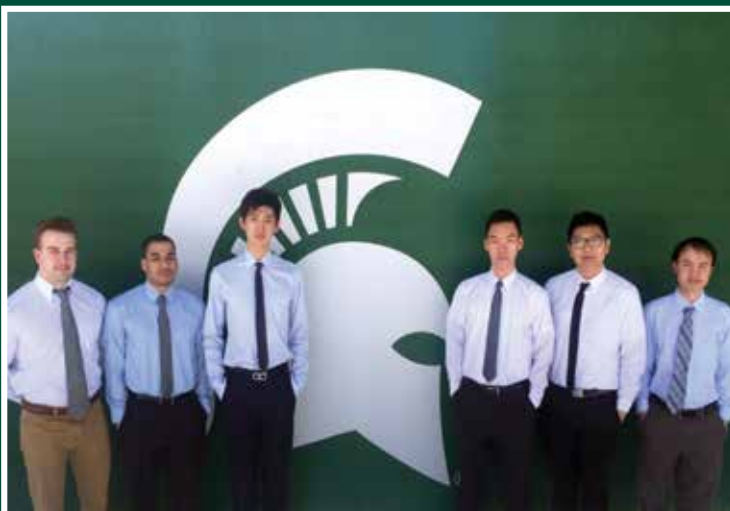

Michigan State University Team Members

Joseph Kim
Rochester Hills, Michigan

Tianlun Liang
Beijing, China

Duan Ni
Dalion, China

Alexander Primeau
Traverse City, Michigan

Travis Tehlirian
Ferndale, Michigan

Tong Wu
Shenzhen, China

Robert Bosch Project Sponsors

Greg Gartland
Farmington Hills, Michigan

Chris Zimmerman
Farmington Hills, Michigan

ME Faculty Advisor
Rod Tabaczynski

Ford Motor Company

Pressure-Reactive Piston Engine

Ford Motor Company has been at the forefront of automotive technology since its inception in 1903. From the integrated moving assembly line to the first full-sized aluminum pick-up truck, Ford's success and longevity have relied heavily upon innovation throughout its history. With the increased demands for fuel economy from both government regulation and consumers, there is a need to develop increasingly fuel-efficient passenger vehicles. One potential opportunity for significant fuel-efficiency gains in internal combustion engines lies in varying the compression ratio within the cylinder under differing load conditions. Historically, variable compression ratio engines have been the subject of considerable research but have lacked the robustness required for commercial viability. Recently, engineers within Ford's Advanced Research and Innovation Powertrain group have developed a spring-loaded piston that may provide the characteristics needed to bring this technology to market.

The design group from Michigan State University has been asked to derive a mathematical model of a piston loaded with a particular kind of spring that would facilitate the implementation of such "pressure-reactive" pistons in internal combustion engines. These piston assemblies are intended to increase compression ratios, and therefore efficiency, under low load conditions while simultaneously eradicating "knock" by passively reacting to the high pressures within the cylinder when under high load conditions. After validation using finite element analysis and physical testing, the mathematical model will be used to optimize the spring design to meet the geometric constraints of a variety of engines.

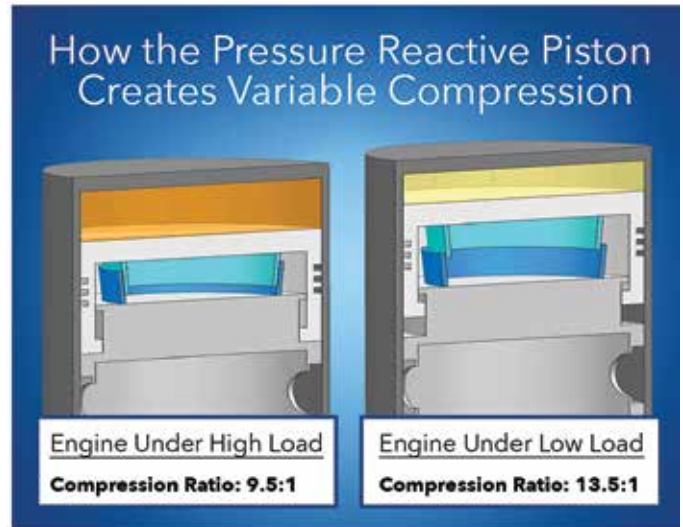

Michigan State University

Team Members

Toby Buckley
Midland, Michigan

Ryan Jacobs
Holland, Michigan

Jacob Kramer
Holland, Michigan

Grant Ridley
Owosso, Michigan

Nicholas Theis
St. Johns, Michigan

Ford

Project Sponsor

John Brevick
Dearborn, Michigan

ME Faculty Advisor
Rod Tabaczynski

Gilbarco Veeder-Root Redesign of a Display Subassembly

Gilbarco Veeder-Root is one of the largest global suppliers of fuel dispensers, point-of-sale systems, payment systems, and support services. Each fuel dispenser utilizes a card reader, PIN pad, and display to interact with the customer. Each component contains PCBAs, wiring, and clamps. In Gilbarco's previous fuel dispenser models, each part was attached directly to the main assembly. In order to increase output for their leading E700 Model, a subassembly was designed for the display components utilizing one metal bracket per unit. This created a more efficient assembly process, which increased production but also increased material cost. Gilbarco is interested in designing a new subassembly concept for their EMV model that increases output of the E700 but reduces material cost.

The MSU team will develop a prototype that will eliminate the need for a bracket in every unit, enabling assembly time to be reduced and material cost decreased. Gilbarco's current bracket subassembly will be redesigned to incorporate a template, which can be removed after the main assembly of each unit. The template will fit the design geometry of the EMV card reader, PIN pad, and display. Each component of the subassembly will be mounted to the template and secured using a fastening mechanism. After attaching the components to the main assembly, the template will be removed and reused on the next subassembly. Thus output is increased while material cost is reduced with the elimination of one metal bracket per unit.



Michigan State University Team Members

Yuhao Chen
Chengdu, China

Kyle Corey
Grand Rapids, Michigan

Shadi Jammoul
Canton, Michigan

Yousib Kammo
Troy, Michigan

Arric McLauchlan
Grand Rapids, Michigan

Gilbarco Veeder-Root Project Sponsors

Danny Seals
Greensboro, North Carolina

Hien Ta
Greensboro, North Carolina

ME Faculty Advisor
Jongeeun Choi

The Capstone Projects



Dr. Giles Brereton
Associate Professor of
Mechanical Engineering

Presentation Schedule – Room 1220

Time	Team Sponsor	Project Title
8:30 a.m.	Consumers Energy	Automated Measurement of Liquid Levels
9:00 a.m.	IAC International	Redesign of a Paint-Line Rack
9:30 a.m.	Kautex Textron	Optimization of Fuel-Tank Baffles
10:00 a.m.	Meritor	Design of a Transfer Case Internal-Oil Cooler
10:30 a.m.	Melvin Millet Learning Center	Switch-Activated Basketball Shooter
11:00 a.m.	Mid-Michigan Children's Museum	Design of an Energy Demonstration Table
11:30 a.m.	Whirlpool	Dual Pumping System for Washing Machines



To view these presentations live please visit the Design Day website: <http://designday.egr.msu.edu> and click the *Watch Live* tab in the left-side menu bar.

Mechanical Engineering Design Program Awards

The Mechanical Engineering Design Program awards prizes in three technical categories and one presentational category on Design Day. The most significant award is the Thomas Alva Edison Design Award—a medal—given to each member of the ME 481 capstone design team that produces the most outstanding technical design project. Each team's technical report is read from cover to cover to evaluate the detailed engineering analyses of each project and assess how much technical Mechanical Engineering value has been added to the project solution by each team. It is not unusual for Mechanical Engineers to include analyses that are more traditionally found in electric, civil, chemical or biomedical engineering, if the project solution requires it. The quality of a team's prototype of its design solution is also an important factor, as is the clarity of its presentation of the design solution. The Edison Award is given to the team which best meets these criteria.

A second ME 481 award is given to the team that gives the best technical project presentation. The importance of communication of scientific and engineering ideas cannot be understated, and it is for this reason that we make the ME 481 Project Presentation Award. Award winners will typically have built an impressive prototype which forms the basis for a very clear and effective presentation of the project background and its solution, often incorporating live or video demonstrations of its functionality. The Design Program also makes awards to the winners of its ME 412 and ME 471 Heat Transfer and Machine Design competitions, the rules and constraints of which vary from semester to semester.

Consumers Energy

Automated Measurement of Liquid Levels

Consumers Energy, headquartered in Jackson, MI, is the largest combined utility company in the state of Michigan, providing natural gas and electric services to approximately two-thirds of the state's residents. In gas delivery systems, a sulfur-scented odorant is added to the gas as a safety precaution. The detection of that odorant outside gas lines is then indicative of gas leaks. For inventory purposes, it is important to be able to measure the levels of the odorant fluid in storage tanks located at the company's nearly 100 natural gas city gates. For decades, Consumers has used a dipstick method for checking the odorant levels at these sites. This method is costly in manpower requirements and the opening of tanks to insert dipsticks can result in false gas leaks being reported.

Consumers Energy desires an innovative solution to allow the collection of odorant level readings with an automated system that can be read both on-site and through their supervisory control and data acquisition system at any time. The MSU team is working to develop a level assessment system that will integrate with the company's existing infrastructure while providing the ability to check odorant levels remotely. The team will demonstrate a prototype system for Consumers to test and refine prior to implementation in the field.



Michigan State University Team Members

Eric Bambach
Troy, Michigan

Ryan Ferguson
Pinckney, Michigan

Alex Hock
Macomb, Michigan

Eric Peters
Wolverine Lake, Michigan

Geoffrey Todd
Walled Lake, Michigan

Consumers Energy Project Sponsors

Kurt Adams
Jackson, Michigan

Kyle Brayton
Jackson, Michigan

Regis Klingler
Jackson, Michigan

ME Faculty Advisor
Farhad Jaber

IAC International Redesign of a Paint-Line Rack

International Automotive Components, Inc. (IAC) has more than 100 years of expertise in the manufacture of automotive interiors. The company has approximately 100 locations in 21 countries, including 25 design, technical and commercial centers, and employs 32,000 people globally. IAC would like to improve the performance of its current paint line by increasing the number of parts (of different sizes and weights) painted on its racks, which is time-consuming and reduces the throughput of parts each day. The current paint line requires frequent changing of racks, which is time-consuming and reduces the throughput of parts each day. The new design is to be an integrated rack which will reduce the number of workers needed to operate the line, create a denser and more efficient workspace and increase the fluidity of its painting operations.

The MSU team will design a range of rack configurations to meet IAC's functionality criteria presented by IAC. The ideal rack will support a range of automotive parts and be optimized for weight, durability and ease of use. A prototype rack will be designed, built and delivered to IAC for testing.



Michigan State University
Team Members

- Ralang Argi**
Jakarta, Indonesia
- Jeremiah Manning**
Detroit, Michigan
- Dahee Park**
Seoul, South Korea
- Daewoong Yang**
Seoul, South Korea

IAC International
Project Sponsors

- Todd Hayes**
Alma, Michigan
- John Tam**
Southfield, Michigan
- ME Faculty Advisor**
Norbert Mueller

Kautex Textron

Optimization of Fuel-Tank Baffles

Textron Inc. is a multi-industry company with operations in 25 different countries and approximately 32,000 employees. Textron is known for its many brands, one of which is Kautex—one of the top 100 suppliers to the automotive industry. Its products include tank systems, selective catalytic reduction systems, clear vision systems and camshafts. Kautex has revolutionized the manufacture of fuel systems by introducing the first plastic fuel tanks to the market. These tanks have advantages over metal tanks such as corrosion resistance, weight reduction, permeation behavior, recyclability, and design freedom. Because of these features, plastic tanks are now used in almost 90% of the United States automobile market.

The MSU team has been asked to optimize the design of baffles located in a fuel tank in order to reduce sound and vibration caused by sloshing fuel motion inside the tank when a vehicle stops. An optimized design should reduce the sloshing noise by at least 50 decibels (db) for the first slosh, and 40 db for the remaining sloshes. The team will design, fabricate and test tank-baffle systems in order to select an optimal design.



Michigan State University Team Members

Zach Averill
Ann Arbor, Michigan

Dave Miller
Grand Haven, Michigan

Adam Polack
Grosse Pointe Farms, Michigan

Hunter St. Pierre
Ann Arbor, Michigan

Bill Weiland
Glen Ellyn, Illinois

Kautex Textron Project Sponsors

Tony Dahm
Troy, Michigan

Peter Ellwood
Troy, Michigan

Rob Wester
Troy, Michigan

General Motors
BJ Foster
Troy, Michigan

ME Faculty Advisor
Indrek Wichman

Meritor

Design of a Transfer Case Internal-Oil Cooler

Meritor is a leading global supplier of automobile components for commercial vehicles and industrial markets, with its headquarters located in Troy, Michigan. During government regulated performance tests, the temperature of Meritor's transfer cases—mechanical assemblies which transfer power between transmissions and axles—can exceed their recommended range. Transfer cases contain many sources of heat including bearings, gears, seals, and the oil pump. Heat is transferred to the surroundings mainly through convection. In one particular performance test, the transfer case is run at a sufficiently low engine speed that the flow of air over the transfer case is too low to cool the transfer case components to acceptably low temperatures. Therefore, additional means of cooling are required.

The goal of this project is to explore design solutions to maintain the transfer case oil temperature within the desired range under both severe (low speed) and normal operating conditions. Two possible solutions: an internal cooling coil and an external heat exchanger, will be evaluated to determine the most promising design. A prototype of the optimal solution will be constructed to demonstrate its ability to fit in or around the transfer case without Meritor having to make significant changes to other features of their current transfer case designs.



Michigan State University

Team Members

Eddie Franklin
Westland, Michigan

Jill Furness
Ann Arbor, Michigan

Lauren Grigg
Novi, Michigan

Trent Hicks
Oak Park, Michigan

Ben Lindemulder
Hudsonville, Michigan

Meritor

Project Sponsors

Todd Ekonen
Troy, Michigan

Laura Klemm
Troy, Michigan

ME Faculty Advisor
Seungik Baek

Melvin Millet Learning Center

Switch-Activated Basketball Shooter

Melvin Millet Learning Center is located in Saginaw, Michigan, and is a school that addresses the unique needs of students with low incidence handicaps. The school has a population of around 270 students that range in age from 3 to 25. Students attending the learning center have from moderate to severe performance challenges that include cognitive impairment, physical impairment, health impairment and autism. The Learning Center currently has a basketball shooter that is 20 years old and has requested that students from Michigan State University design a new basketball shooter that can be used during games of wheelchair basketball.

The MSU team has been challenged to design a new basketball shooter that will allow students unable to manipulate the ball to participate in the activities. The new shooter design will be engineered so that it meets all safety requirements and will have a long service life. It must allow for ease of adjustment during use. It must be designed to be moved during and after use for storage and, due to the severe disabilities of some students, the shooter must be activated via a simple push button or proximity sensor. A prototype will be designed, built and tested at MSU before delivery to the Learning Center for further evaluation.



SAGINAW ISD
MILLET LEARNING CENTER

GM FOUNDATION



Michigan State University Team Members

Michael Campbell
Ortonville, Michigan

Jinbo Chen
Dalian, China

Michael Cieslik
Romeo, Michigan

Anthony LaCross
Traverse City, Michigan

Seth Rohr
Otsego, Michigan

Melvin Millet Learning Center Project Sponsor

Elizabeth Pan
Saginaw, Michigan

General Motors Foundation

Andrew Herman
Warren, Michigan

ME Faculty Advisor
Elisa Toulson

Mid-Michigan Children's Museum

Design of an Energy Demonstration Table

Mid-Michigan Children's Museum is located in Saginaw, Michigan. The museum accommodates children from birth to twelve years of age and provides exposure to interesting displays of everyday physical phenomena. The museum attempts to provide an environment in which children use their curiosity and creativity to learn about their world. The award-winning museum features interactive exhibits to facilitate learning. One display that demonstrates the concept of gear ratios is in need of redesign. The current exhibit is too complicated and appears to intimidate children.

The MSU design team was asked to upgrade the current exhibit so that children can easily understand how to use it and be exposed to the concept of gear ratios. The MSU team will consider various factors that must be taken into account when designing interactive mechanisms for children including safety, simplicity, and durability. For the design to achieve maximum functionality, it must be visually appealing and incorporate a straightforward assembly process for children who lack fine motor skills. The reconditioned display will allow children to create their own setups and will also include figures on the gears to demonstrate their rotational motion. The group will design and build a demonstration table and the upgraded gear exhibit to deliver to the museum.



Michigan State University Team Members

Jay Heribacka
Munising, Michigan

Gregory Lott
Gardners, Pennsylvania

Thomas Stevenson
Grand Rapids, Michigan

Ethan Welzbacker
Saline, Michigan

Barrett Winrick
Minneapolis, Minnesota

Mid-Michigan Children's Museum Project Sponsor

Mike Colucci
East Lansing, Michigan

ME Faculty Advisor
Elisa Toulson

Whirlpool Corporation

Dual Pumping System for Washing Machines

Founded and headquartered in Benton Harbor, Michigan, Whirlpool Corporation is the world's largest major manufacturer, with 70 manufacturing and technology research centers throughout the world. For many years, Whirlpool has created high-quality washing machines that are both reliable and innovative. Currently, standard washing machines include a drain pump while higher efficiency models also feature a recirculation pump. This additional pump recirculates detergent-rich water from the base of the tub back onto the clothes, thus conserving water and saving energy while providing better cleaning. Although this system conserves water for the consumer, the overall unit cost is higher due to two separate pump motors. Whirlpool is, therefore, interested in designing a pumping system which combines the drain and recirculation pumps. The new system must be able to function and maintain the same standards of the individual pump systems while only using one motor.

The MSU team will create new concepts for this combined system that meet the specified Whirlpool requirements. A Pugh Matrix will be utilized to determine the most inventive and effective design. A prototype of the optimal design will be built, tested, and refined, then delivered to Whirlpool for further evaluation.



Michigan State University

Team Members

JD Alocilja
East Lansing, Michigan

Travis Collings
Bad Axe, Michigan

Ravin Kelser
Southfield, Michigan

Shannon Pinner
Rockford, Michigan

Madeline Roe
Grayslake, Illinois

Whirlpool Corporation

Project Sponsors

David Goshgarian
St. Joseph, Michigan

Basak Oguz
St. Joseph, Michigan

ME Faculty Advisor
Neil Wright

Design Day Awards

ME 481 Thomas Alva Edison Undergraduate Design Award



Left to right: Anthony Kazenko, Brett Close, Alexander Williams, David Torres, and Luke Ferguson

The Edison Undergraduate Design Award is given to the ME 481 Design Team that is judged to have produced the most outstanding technical design project.

Last semester's Edison Scholars were Brett Close, Luke Ferguson, Anthony Kazenko, David Torres, and Alexander Williams. They carried out a project sponsored by Meritor of Troy, Michigan, in which they used computational methods to find an optimal design for an axle-bowl cover using composite materials.

ME 481 Project Presentation Award:

The ME 481 Project Presentation Award is given to the ME 481 Design Team that is judged to have given the best technical project presentation. Last semester's winners, Darius Barrett, Trent Johnson, Frank Luchini, Casey Nicholson, and Luke Steele, gave an outstanding presentation of their design of a floor-to-seat personal elevation system for Heartwood School in Mason, Michigan.



Left to right: Trent Johnson, Darius Barrett, Luke Steele, Casey Nicholson, and Frank Luchini

ME 471 Machine Design Award: The Leonardo da Vinci Award

The Leonardo da Vinci Award is given to the winning team in the ME 471 machine design competition on Design Day. Last semester's winners, for the best horizontal cereal conveyor, were Angela Bertolini, Nick Theis, Mariya Titova, and Kevin Viguilla.



Left to right: Mariya Titova, Kevin Viguilla, Nick Theis, and Angela Bertolini



Building Dreams Building Community

From purchasing a new computer, an upgraded apartment, or your first car, it's our mission to help you achieve your financial goals and dreams. Our financial services tools will help to financially prepare you for every stage in life, bringing you one step closer to achieving those goals and dreams.

Learn how you can save money with a financial education seminar at MSUFCU.
Visit our website for internships and careers in technology.

***MSU Federal Credit Union is proud to support the
Michigan State University College of Engineering Design Day.***



517-333-2424 • 800-678-4968

www.msufcu.org



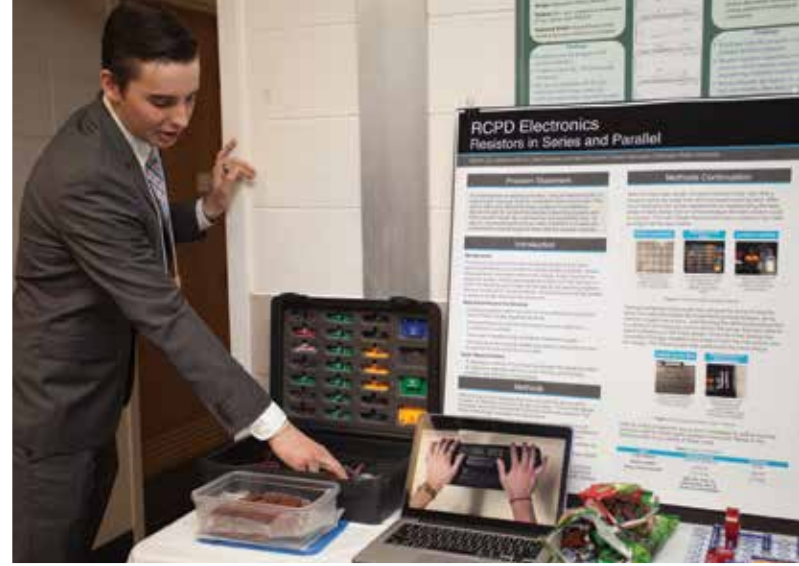



BRING YOUR KNOWLEDGE FROM THE CLASSROOM TO REAL LIFE

Scientific curiosity runs in our veins and drives us to uncover hidden opportunities. We utilize scientific analysis, process-optimizing software and experienced consultants to deliver solutions to virtually every automotive manufacturer in more than 60 countries.

Our growing company needs people who share our commitment to go beyond the obvious to solve business problems that others can't.

Are you ready to take the knowledge you've gained from the classroom, and apply it to realworld situations?

Visit urbanscience.com/careers



Proud Sponsors of the Michigan State University Capstone Experience Lab

*Urban Science has sponsored 13
CSE capstone projects and hired 29
MSU graduates*



URBAN SCIENCE



URBAN SCIENCE.

Directing Partner Sponsor

**For information on
sponsoring Design Day
and design projects, contact**

Dr. Wayne Dyksen
Executive Director, Design Day
(517) 353-5573 dyksen@msu.edu

Jill Bielawski
Director, Design Day
(517) 353-8133 bielawsk@egr.msu.edu